

AGENDA

SCHOOL BOARD WORKSHOP

GADSDEN COUNTY SCHOOL BOARD
MAX D. WALKER ADMINISTRATION BUILDING
35 MARTIN LUTHER KING, JR. BLVD.
QUINCY, FLORIDA

January 21, 2010

6:00 P.M.

THIS WORKSHOP IS OPEN TO THE PUBLIC

1. CALL TO ORDER

2. ITEMS FOR DISCUSSION

a. Vacant Properties

- Faith Apostolic Christian Services – Chattahoochee High School
SEE PAGE #58
- The Sons of God Ministry – Old Southside Elementary School – **SEE PAGE #85**
- Lerther Jones Yhap Outreach Ministries - Old Southside Elementary School
SEE PAGE #86
- Searching For The One Ministries, Inc. – Havana Northside High School –
SEE PAGE #100
- Havana Community Development Corp. - Havana Northside High School

3. ITEMS BY THE SUPERINTENDENT

4. SCHOOL BOARD REQUESTS AND CONCERNS

5. ADJOURNMENT

Vacant property owned by School Board

Property Name	Date Vacated (year)	Number of Acres	Number of Buildings	Square Footage of Total Buildings	Year Constructed	Condition of Buildings	Last Appraisal Date	Appraisal Value	Property Accessed Value
McClain Property	2000	25	0	0	1996	N/A	1996	\$117,500	\$150,000
Havana Northside	May 2003	21	2	58,054	1970	Poor	August 2003	Low \$2,000,000 High \$3,400,000	\$1,449,110
Chattahoochee High	May 2004	31	5	74,825	(1)1967 (2)1982 (3)1953 (4)1948 (5)1979	Poor	September 2004	\$3,300,000	\$584,250
Greensboro Elementary	December 2007	11	8	48,591	(1)1958 (2)1958 (3)1963 (4)1971 (5)1960 (6)1962 (7)1964 (8)1973	Fair/Good	June 2008	\$1,860,000	\$722,579

Wayne Shepard-Director of Facilities
 805 South Stewart Street
 627-9888
 545-7918
shepardw@mail.gcps.k12.fl.us

MR

**MATTOX
REALTY, INC.**

Residential
Commercial
Leasing
Development
&
Consulting

800 North Calhoun St
Tallahassee, Florida 32303

P.O. Box 4164
Tallahassee, Florida 32315-4164

(850) 383-1966
Fax (850) 297-1023

mattoxrealty.com
comments@mattoxrealty.com

February 12th 2009

Mr. Wayne Shepard
Director of Facilities
Gadsden County Schools
35 Martin Luther King Jr. Boulevard
Quincy, Florida 32351

RE: Former Greensboro, Havana-North and Chattahoochee High School

Dear Mr. Shepard:

Overview:

Marketing period of 3-5 years would be required

Commission at 8% paid at closing

Recommending a listing price for each project as follows:

The Chattahoochee High School
613 Chattahoochee Street
Gadsden County Florida 32351
Listing Range: \$1,250,000-\$1,850,000

Havana-North Side High School
US Hwy 27
Havana, Florida
Listing Range: \$1,150,000-\$1,500,000

Greensboro Elementary School
62 Lonnie Clark Drive
Gadsden County, Florida 32351
Listing Range: \$750,000-1,100,000

We would request that the Gadsden County School Board cover expenses for the on site signs and virtual tours of each property. Each property would require some site preparation prior to scheduling a virtual tour and pictures.

Should you have any questions or comments, please do not hesitate to give me a call.

Regards,

Suzanne McGhee
Mattox Realty, Inc.
850.556.2299 direct

Gadsden County Parcel Maps

[Gadsden Home](#) | [Map Help](#) | [Turn Quick Info On](#) | [Search Page](#)

- Zoom Out
- Zoom In
- Panby Hand
- Zoom to Box
- Zoom County
- Get Info
- Zoom To Parcel
- Center On Parcel
- Measure
- Area Tool
- Print Page
- Search Sales



- Show:
- Parcels
 - Roads
 - Lakes & Rivers
 - Elevation
 - Railroads
 - Yearly Sales
 - Parcel Numbers
 - Lots
 - Dimensions
 - Sec-Twn-Rng
 - Future Land Use
 - Aerial Photography

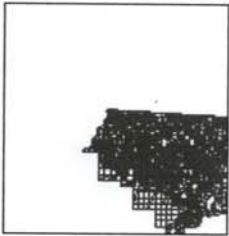

1:7,534

Report Legend

PARCEL INFORMATION TABLE			
Selected Parcel	2-03-3N-6W-0000-00314-0800 (Click for Complete Card)		
DOR Property Usage	SCHOOLS, PUBLIC (83)		
Acres	1.64		
Property Use	PUBLIC SCH		
Land Use	SCHOOL		
OWNERSHIP INFORMATION			
Name	SCHOOL BOARD OF GADSDEN COUNTY		
Mailing Address	COUNTY FLA ACROSS FROM OLD SOUTH-SIDE CHT; 35 MARTIN LUTHER KING BLVD QUINCY, FL 32351		
Situs/Physical Address	LINCOLN DR		
VALUES			
Land Value	8,200		
Ag Land Value	0		
Building Value	0		
Misc Value	0		
Just Value	8,200		
Assessed Value	8,200		
Exempt Value	8,200		
Taxable Value	0		
Homestead?	N		
LAST 2 SALES			
Date	Price	Vacant?	Qual

The Gadsden County Property Appraiser's Office makes every effort to produce the most accurate information possible. No warranties, expressed or implied, are provided for the data herein, its use or interpretation. The assessment information is from the last certified taxroll. All data is subject to change before the next certified taxroll. PLEASE NOTE THAT THE PROPERTY APPRAISER MAPS ARE FOR ASSESSMENT PURPOSES ONLY NEITHER GADSDEN COUNTY NOR ITS EMPLOYEES ASSUME RESPONSIBILITY FOR ERRORS OR OMISSIONS ---THIS IS NOT A SURVEY---

[Gadsden Home](#) ----- [Search Page](#)
© Website design by [qpublic.net](#)

NOTE: The City of Chattahoochee currently leases the approximately 1.64 acres from the School Board. On December 4, 2009, the City submitted a letter stating their intention to terminate this lease within ninety days. The current lease is attached.



CITY of CHATTAHOOCHEE

POST OFFICE BOX 188
CHATTAHOOCHEE, FLORIDA 32324-0188
www.ci.chattahoochee.fl.us

CITY HALL

Telephone: (850) 663-4046
Fax: (850) 663-2456
E-mail: cityclerk@gtcom.net

UTILITY & PUBLIC WORKS

Telephone: (850) 663-4475
Fax: (850) 663-4233
E-mail: citymgr@gtcom.net

PUBLIC SAFETY

Telephone: (850) 663-4383
Fax: (850) 663-8510
E-mail: vannpullen@gtcom.net

PARKS & RECREATION

Telephone: (850) 663-2123
Fax: (850) 663-3800
E-mail: crmserv@gtcom.net

December 4, 2009

Mr. Reginald James, Superintendent
The School Board of Gadsden County
35 Martin Luther King, Jr. Boulevard
Quincy, Florida 32353

Dear Superintendent James:

This letter is notification that the City Council of the City of Chattahoochee voted at its December meeting to exercise its option under Section 2 (I) of the original agreement, as amended for the Southside School Facility, by giving you ninety (90) days notice of our intent to terminate the lease agreement.

Thank you for the use of the facility over the past years and we look forward to working together on future projects of benefit to the city and your board. I will be the contact person for the city to coordinate the turn over with your staff.

Sincerely,

ELMON LEE GARNER
CITY MANAGER

CC: City Attorney
Mayor & Council

LEASE

THIS INDENTURE made and entered into in Gadsden County, Florida, on this 21st day of November, A.D. 1989, by and between THE SCHOOL BOARD OF GADSDEN COUNTY, FLORIDA, hereinafter called LESSOR, and CITY OF CHATTAHOOCHEE, FLORIDA, a municipal corporation organized and existing under the laws of the State of Florida, hereinafter called LESSEE.

W I T N E S S E T H :

That for and in consideration of the rent to be paid by LESSEE to LESSOR as hereinafter agreed, and also particularly in consideration of the agreements and covenants to be performed by LESSEE as hereinafter set forth, LESSOR does hereby lease and demise unto LESSEE and LESSEE does hereby take that certain property in the City of Chattahoochee, County of Gadsden and State of Florida, more particularly described as follows:

Begin at the Southeast Corner of the Northeast Quarter of the Southwest Quarter of Section 3, Township 3 North, Range 6 West and run West 120.3 feet to the West side of State Road 269-A (old wire road); thence run South 27 degrees 37 minutes East 73.3 feet, thence run South 61 degrees 31 minutes West 679.65 feet; thence run North 714.25 feet; thence run North 82 degrees 30 minutes East 240.4 feet; thence run South 42.92 feet; thence run East 445.78 feet; thence run South 313.15 feet to the Point of Beginning. LESS AND EXCEPT RIGHT OF WAY OF STATE ROAD S-269-A. Said lands being a part of the East half of the Southwest Quarter of Section 3, Township 3 North, Range 6 West.

Situate, lying and being in the City of Chattahoochee, County of Gadsden and State of Florida.

TO HAVE AND TO HOLD the same for a period of Ten (10) years, commencing on the first day of December, 1989, and ending at midnight on the 30th day of November, 1999, upon the following terms and conditions:

1. RENTAL:

LESSEE hereby covenants and agrees to pay to LESSOR for rental of the aforesaid premises the sum of \$1.00 per year, the same to be paid in advance on or before the 10th day of December of 1989 and each succeeding year thereafter.

2. LESSEE'S COVENANTS:

LESSEE hereby covenants with LESSOR as follows:

(a) That LESSEE will maintain insurance coverage for fire, lightning, and other perils upon the leased premises in an amount of at least \$100,000 on the building of brick construction located on the property, and in the event of damage or destruction by fire or wind shall repair or replace the improvements or terminate this lease at its option, and if the leased premises are rendered untenable by fire or wind the rental shall abate for the period of time that the premises are unuseable. That such insurance shall be maintained in the name of both LESSOR and LESSEE as their respective interests may appear.

(b) That LESSEE will carry tort liability insurance covering said premises with at least the minimum limits of liability as provided by law, the same presently being \$100,000/\$200,000 at the time of the execution of this lease, and LESSEE shall protect and hold harmless LESSOR from any claims whatsoever by any person whomsoever resulting from LESSEE's business operation and activities upon the premises and LESSEE'S occupancy thereof, and LESSEE will furnish LESSOR certificates of such insurance.

(c) That LESSEE will pay said rental at the time the same accrues and comply with all covenants charging duties to LESSEE.

(d) That LESSEE will use the leased premises for recreational, Educational, Community Activities, or related

purposes of a public benefit to the community, and will not make nor suffer any unlawful use or occupancy of the premises.

(e) That LESSEE will promptly pay all charges and accruals which might occur against that premises resulting from any business or activities operated thereon, whether such be for utilities or otherwise, during the term of this lease or any extension thereof.

(f) That LESSEE will maintain both the exterior and interior of the leased property, including ceilings, walls, floors, fixtures, pipes, doors and windows, heating and electricity, in good and substantial repair. That LESSEE will keep said premises free from filth, danger of fire, or any nuisance. That LESSEE will repair or pay for any damage caused by its use and occupancy of the leased premises and at the termination of this lease will return the premises in as good repair as at the date of this lease, ordinary wear and tear excepted.

(g) That at the expiration of the lease term, LESSEE will peacefully yield up to LESSOR, its successors or assigns, said leased premises.

(h) That no assent, expressed or implied, by LESSOR to any breach of LESSEE'S covenants herein shall be deemed to be a waiver to any succeeding breach of the same covenant.

(i) The LESSOR agrees in advance that LESSEE may sublet the above described premises to the Community Awareness Program, or Similar Organization. However LESSEE may not otherwise sell or assign this lease nor sublet any part or all of the premises without the written consent of LESSOR, but that consent shall not unreasonably be withheld.

(j) That LESSEE will pay all taxes or assessments, if any, made or assessed against the real property hereby leased.

(k) That LESSEE shall have the right to make reasonable alterations and improvements of the leased premises to place the same in useable condition for LESSEE'S purposes, but any such alterations or improvements shall be made at LESSEE'S expense.

(l) LESSEE may terminate this lease at its option by giving LESSOR at least ninety (90) days prior written notice of its intention to terminate the lease, said notice to specifically set forth the exact date when the termination shall become effective.

3. LESSOR'S COVENANT:

(a) That LESSOR guarantees that LESSEE upon paying the rentals as herein specified and performing the covenants to be performed by LESSEE shall have the peaceful and quiet possession of the premises during the full term hereof and any extension thereof.

4. In the event LESSEE should default in the payment of any rental due or any of the other terms and provisions hereof, and such default should continue for a period of thirty days, LESSOR may, at its option, terminate said lease and regain possession of said premises by any manner or means as is now or may be provided by law and shall have a lien upon any property usually kept on said premises for the amount of such defaulted rental and costs of collecting the same, and shall have such other relief as may be provided by law.

5. This lease shall automatically be renewed for additional ten-year periods, on the same terms and conditions as provided herein, unless either party hereto

gives written notice to the other of its desire to terminate the lease at least ninety days prior to the end of the primary term or the end of any renewal term.

6. Time shall be of the essence of this agreement.

7. All the terms and conditions of this lease shall be binding upon the successors and assigns of the parties hereto.

IN WITNESS WHEREOF, the parties hereto have set their hands and seals the day and year first above written, in duplicate.

SIGNED, sealed and delivered in our presence as witnesses:

John H. Moon Jr

Susan K. Yates

Gayle Lanier

Kimberly E. Parnell

L E S S O R

THE SCHOOL BOARD OF GADSDEN COUNTY, FLORIDA

BY: William Stewart
Its Chairman

ATTEST:

Robert H. Burch
Secretary

L E S S E E

CITY OF CHATTAHOOCHEE, FLORIDA

BY: Robert D. Hayes
Its Mayor and
Presiding Officer of
the City Council

ATTEST:

Charles R. Sparks
Its Clerk

STATE OF FLORIDA
COUNTY OF GADSDEN

BEFORE ME, the undersigned authority, this day personally appeared H. Jefferson Davis, Jr. and Robert H. Bryant, known to me to be the Chairman and Secretary, respectively, of THE SCHOOL BOARD OF GADSDEN COUNTY, FLORIDA in and who executed the foregoing instrument and acknowledged before me that they executed the same in the aforesaid capacities, that they are duly authorized to do so, and that they executed the same for the uses and purposes therein expressed.

WITNESS my hand and seal this 21st day of November, A.D. 1989.

Notary Public
My Commission Expires:
NOTARY PUBLIC, STATE OF FLORIDA.
MY COMMISSION EXPIRES: JULY 17, 1992.

STATE OF FLORIDA
COUNTY OF GADSDEN

BEFORE ME, the undersigned authority, this day personally appeared Robert D. Hayes and Charles B. Sparks, known to me to be the Mayor and Presiding Officer and the Clerk, respectively, of the CITY OF CHATTAHOOCHEE, FLORIDA, a municipal corporation organized and existing under the laws of the State of Florida, and who acknowledged before me that they executed the foregoing instrument in such capacities, in the name of, for and on behalf of said City, with full authority to do so, and that they executed the same for the uses and purposes therein expressed.

WITNESS my hand and seal this 8th day of November, A.D. 1989.

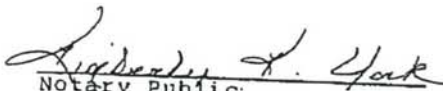
Notary Public
My Commission Expires:

Notary Public State of Florida at large
My Commission Expires June 13, 1991

ADDENDUM TO LEASE

This Addendum to Lease made and entered into in Gadsden County, Florida on this 25th day of April, 1995, by and between THE SCHOOL BOARD OF GADSDEN COUNTY, FLORIDA, hereinafter called "Lessor", and THE CITY OF CHATTAHOOCHEE, FLORIDA, a municipal corporation organized and existing under the laws of the State of Florida, hereinafter called "Lessee", in consideration of the existing lease agreement, and mutual obligations to be performed thereunder, and

WHEREAS, the parties hereto have previously entered into a lease agreement dated December 1, 1989, whereby the City of Chattahoochee as Lessee has leased from the School Board of Gadsden County as Lessor, certain real property located on Lincoln Drive in the City of Chattahoochee and known as the Old Southside School Property; said property being more particularly in the lease agreement, and

WHEREAS, that lease agreement presently provides for a term of ten (10) years commencing on the 1st day of December, 1989 and ending at midnight on the 30th day of November, 1999, with a further provision that the lease shall automatically be renewed for additional ten (10) year periods, on the same terms and conditions as provided herein, unless either party hereto gives written notice to the other of its desire to terminate the lease, and

WHEREAS, the School Board of Gadsden County Florida at its regularly scheduled meeting on Tuesday, July 26, 1994, approved an amendment to said lease which had been requested by the City of Chattahoochee the same being that the term of the lease be extended for successive periods of twenty five (25) years,

NOW THEREFORE, the parties agree to amend the lease as follows:

1. The Lessee shall have the right to have and to hold the real property which is the subject of the lease for a period of twenty five (25) years, commencing on the 1st day of August, 1994, and ending at midnight on the 30th day of November, 2019.

2. This lease shall automatically be renewed for additional twenty five (25) year periods, on the same terms and conditions as provided herein, unless either party hereto gives written notice to the other of its desire to terminate the lease at least ninety days prior to the end of the primary term or the end of any renewal term.

IN WITNESS WHEREOF, the parties hereto have set their hands and seals the day and year first above written, in duplicate.

SIGNED, sealed and delivered in our presence as witnesses

John D. Oliver
John W. Brown, Jr.

James D. ...
Wayne Lanier

L E S S O R

THE SCHOOL BOARD OF GADSDEN COUNTY, FLORIDA

BY: Catherine S. James
Its Chairman

ATTEST:

Harold J. Henderson
Secretary

CITY OF CHATTAHOOCHEE FLORIDA

BY: Wayne A. ...
Its Mayor and Presiding Officer of the City Council

ATTEST:

Charles B. ...
Its Clerk

STATE OF FLORIDA
COUNTY OF GADSDEN

BEFORE ME, the undersigned authority, this day personally appeared Catherine S. James and Harold J. Henderson, personally known to me to be the Chairman and Secretary, respectively, of THE SCHOOL BOARD OF GADSDEN COUNTY, FLORIDA in and who executed the foregoing instrument and acknowledged before me that they executed the same in the aforesaid capacities, that they are duly authorized to do so, and that they executed the same for the uses and purposes therein expressed.

WITNESS my hand and seal this 25th day of April, A.D. 1994.1995



JANE W. BUTLER
MY COMMISSION # CC295657 EXPIRES
July 18, 1997
BONDED THRU TROY FAIR INSURANCE, INC.

Jane W. Butler
Notary Public
My Commission Expires:

STATE OF FLORIDA
COUNTY OF GADSDEN

BEFORE ME, the undersigned authority, this day
personally appeared Charles B. Sparks and Doyle A. Hines and
Charles B. Sparks, personally known to me to be the
Mayor and Presiding Officer and the Clerk, respectively, of the
CITY OF CHATTAHOOCHEE, FLORIDA, a municipal corporation organized
and existing under the laws of the State of Florida, and who
acknowledged before me that they executed the foregoing instrument
in such capacities, in the name of, for and on behalf of said City,
with full authority to do so, and that they executed the same for
the uses and purposes therein expressed.
WITNESS my hand and seal this 7th day of
June, A.D. 1995

Mary Ann Jernigan
Notary Public
My Commission Expires:



MARY ANN JERNIGAN
MY COMMISSION # GC440098 EXPIRES
February 20, 1999
BONDED THROUGH TRISTY FAIR INSURANCE, INC.

FLORIDA DEPARTMENT OF EDUCATION
OFFICE OF EDUCATIONAL FACILITIES

* 1989 FISH *

SCHOOL FACILITIES INVENTORY

DISTRICT 20 GADSDEN
COUNTY SUPERINTENDENT'S OFFICE
P.O. BOX 818
QUINCY

32351

ADM#	PAR#	OWNER	ACRE	YRACQ	COC	GRADES	USE	BLDG TYPE	WATER	SEWER		
9001	OO1	SCH BD	5	1927	3	OK-12	VACANT	CAMPUS	PUBLIC	OS TNK		
POLICE	FIRE	PLAYGD	LANDSCAPE	PARKING	ATHFLD	DRAIN	VALIDATION DATE					
COMB	8	PRT DEV	PRT DEV	PRT DEV	NONE	INADQ	OO/00/0000					
BLDG#	PRIM USE	OWNER	REL UNIT	STRUCTURE	WALLS	STORY	COR LD	HEAT SRC	DISTRIB	CAPACITY	COOLING	
O1	ELM SCH	SCH BD	OO	COMBINATN	BRICK	1	DBL INSD	GAS	STEAM Z	ADQ	NONE	
VENT NO	TYPE LITE	LITE ADQ	EM LITE	PHONE	INTRCOM	TV SYS	FIRE ALRM	SPRNKLR	FIRE HOSE	EXTNG	YR CONST	
	GLOBE FIX	ADQ	NO	PART SYS	NONE	NONE	YES	NONE	NO	YES	1960	
ROOM	SUF	AREA	FLOOR	DESIGN#	DESIGN NAME	COOLING	FLRCV	TCH STA	STU	STA	COND	CONST
001		874	1	454	WORKROOM PR	NONE	TILE				UNSAT	1960 20001900101
002		874	1	454	WORKROOM PR	NONE	TILE				UNSAT	1960 20001900101
003		44	1	454	WORKROOM PR	NONE	TILE				UNSAT	1960 20001900101
004		874	1	454	WORKROOM PR	NONE	TILE				UNSAT	1960 20001900101
005		90	1	454	WORKROOM PR	NONE	TILE				UNSAT	1960 20001900101
006		270	1	454	WORKROOM PR	NONE	CONCRTE				UNSAT	1960 20001900101
007		302	1	454	WORKROOM PR	NONE	TILE				UNSAT	1960 20001900101
008		207	1	454	WORKROOM PR	NONE	CERAMIC				UNSAT	1960 20001900101
009		207	1	454	WORKROOM PR	NONE	CERAMIC				UNSAT	1960 20001900101
010		874	1	454	WORKROOM PR	NONE	TILE				UNSAT	1960 20001900101
011		874	1	454	WORKROOM PR	NONE	TILE				UNSAT	1960 20001900101
012		874	1	454	WORKROOM PR	NONE	TILE				UNSAT	1960 20001900101
013		43	1	454	WORKROOM PR	NONE	TILE				UNSAT	1960 20001900101
014		43	1	454	WORKROOM PR	NONE	TILE				UNSAT	1960 20001900101
015		874	1	454	WORKROOM PR	NONE	TILE				UNSAT	1960 20001900101
016		1650	1	454	WORKROOM PR	NONE	TILE				UNSAT	1960 20001900101
017		240	1	454	WORKROOM PR	NONE	CONCRTE				UNSAT	1960 20001900101

FLORIDA DEPARTMENT OF EDUCATION
OFFICE OF EDUCATIONAL FACILITIES

* 1989 FISH *

SCHOOL FACILITIES INVENTORY

DISTRICT 20 GADSDEN
COUNTY SUPERINTENDENT'S OFFICE
P.O. BOX 818
QUINCY 32351

BLDG#	PRIM USE	OWNER	REL UNIT	STRUCTURE	WALLS	STORY	COR LD	HEAT SRC	DISTRIB	CAPACITY	COOLING
01	ELM SCH	SCH BD	OO	COMBINATN	BRICK	1	DBL INSD	GAS	STEAM Z	ADQ	NONE
VENT	TYPE LITE	LITE ADQ	EM LITE	PHONE	INTRCOM	TV SYS	FIRE ALRM	SPRNKLR	FIRE HOSE	EXTNG	YR CONST
NO	GLOBE FIX	ADQ	NO	PART SYS	NONE	NONE	YES	NONE	NO	YES	1960
PERMANENT	TOTAL SAT	0									
PERMANENT	TOTAL UNSAT	9214						0	0		
PERMANENT	BLDG TOTAL	9214						0	0		

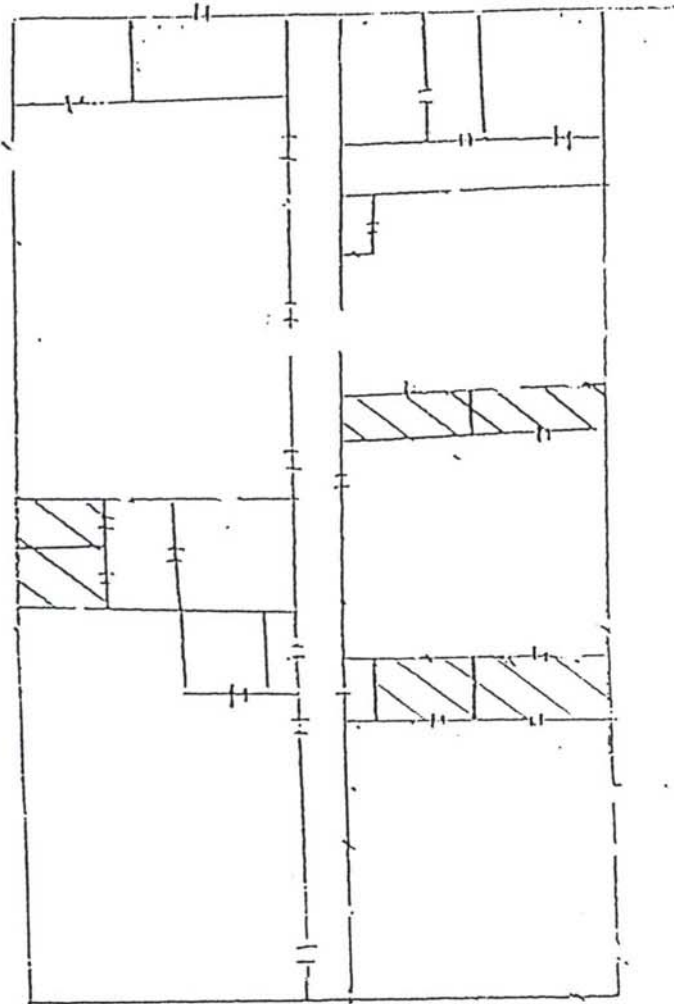

Hand-drawn floor plan

**Chattahoochee
Southside Elementary**

Gadsden County Parcel Maps

[Gadsden Home](#) | [Map Help](#) | [Turn Quick Info On](#) | [Search Page](#)

Zoom Out **Zoom In**

Zoom to Parcel **Center On Parcel**

Print Page **Search Sales**

Show:

- Parcels
- Roads
- Lakes & Rivers
- Railroads
- Yearly Sales
- Parcel Numbers
- Lots
- Dimensions
- Sec-Twn-Rng
- Future Land Use
- Aerial Photography

1:9,001



PARCEL INFORMATION TABLE			
Selected Parcel	1-33-4N-6W-0000-00442-0000 <small>(Click for Complete Card)</small>		
DOR Property Usage	SCHOOLS, PUBLIC (83)		
Acres	33		
Property Use	PUBLIC SCH		
Land Use	SCHOOL		
OWNERSHIP INFORMATION			
Name	SCHOOL BOARD OF GADSDEN COUNTY		
Mailing Address	COUNTY FLA CHATTAHOOCHEE HIGH; 35 MARTIN LUTHER KING BLVD QUINCY, FL 32351		
Situs/Physical Address	613 CHATTAHOOCHEE ST		
VALUES			
Land Value	74,250		
Ag Land Value	0		
Building Value	0		
Misc Value	510,000		
Just Value	584,250		
Assessed Value	584,250		
Exempt Value	584,250		
Taxable Value	0		
Homestead?	N		
LAST 2 SALES			
Date	Price	Vacant?	Qual

The Gadsden County Property Appraiser's Office makes every effort to produce the most accurate information possible. No warranties, expressed or implied, are provided for the data herein, its use or interpretation. The assessment information is from the last certified taxroll. All data is subject to change before the next certified taxroll. PLEASE NOTE THAT THE PROPERTY APPRAISER MAPS ARE FOR ASSESSMENT PURPOSES ONLY NEITHER GADSDEN COUNTY NOR ITS EMPLOYEES ASSUME RESPONSIBILITY FOR ERRORS OR OMISSIONS ---THIS IS NOT A SURVEY---

[Gadsden Home](#) [Search Page](#)
 © Website design by [qpublic.net](#)

NOTE: The State of Florida currently leases to the School Board an area to be used for athletic facilities. The lease agreement is attached and numbered 3263.

BOARD OF TRUSTEES OF THE INTERNAL IMPROVEMENT TRUST FUND

LEASE AGREEMENT

(1) 3263

No. 3263

WHEREAS, the Board of Trustees of the Internal Improvement Trust Fund of the State of Florida holds title to certain lands and property being utilized by the State of Florida for public purposes, and

NOW, THEREFORE, this agreement made between the BOARD OF TRUSTEES OF THE INTERNAL IMPROVEMENT TRUST FUND of the State of Florida, as LESSOR, and the SCHOOL BOARD OF GADSDEN COUNTY, as LESSEE.

WITNESSETH:

The parties, for and in consideration of mutual covenants and agreements hereinafter contained, hereby covenant and agree as follows:

1. The lessor does hereby lease to the lessee the following described premises in the County of Gadsden, State of Florida, together with the improvements thereon (if applicable), viz:

(Exhibit A - attached)

TO HAVE AND TO HOLD the above described land for a period of Forty (40) years for the site of a physical education/ athletic complex and related uses.

2. The lessee shall have the right to enter upon said land for all purposes necessary to the full enjoyment by said lessee of the rights herein conveyed to it.

3. The lessee shall through its agents and employees prevent the unauthorized use of said land or any use thereof not in conformity with this lease.

4. This lease shall terminate at the sole option of the lessor, and the lessee shall surrender up the premises to the lessor, when and if said premises, including lands and improvements shall cease to be used for the site of a physical education/athletic complex and related uses.

No. 3263

Any costs arising out of the enforcement of the terms of this lease agreement shall be the exclusive obligation of the lessee, payable upon demand of the lessor.

5. The lessee hereby covenants and agrees to investigate all claims of every nature at its own expense and to indemnify, protect, defend, hold and save harmless the lessor from any and all claims, actions, lawsuits and demands of any kind or nature arising out of this agreement to the extent allowable by law.

6. The lessor does not warrant or guarantee title, right or interest in the hereinabove described property.

7. The lessor or its duly authorized agents shall have the right at any time to inspect the said land and the works and operations thereon of the lessee in any matter pertaining to this agreement.

8. The lessee agrees to assume all responsibility for liabilities that accrue to the subject property or to the improvements thereon, including any and all drainage or special assessments or taxes of every kind and description which are now or may be hereafter lawfully assessed and levied against the subject property during the effective period of this lease.

9. The lessee is hereby authorized to grant utility easements which will be necessary to service authorized facilities located within the leased premises. Copies of any such easements granted shall be filed timely with the lessor.

10. This agreement is for the purposes specified herein, and subleases of any nature, excepting utility easements incident to authorized facilities, (Provision 9), are prohibited, unless previously authorized by the lessor.

11. Upon cessation of occupation of said property, the lessee agrees to leave all fixed improvements for the use of the lessor and to put no claim upon said fixed improvements; or, at the option of the lessor, the lessee agrees to remove any or all improvements on the property at the lessee's expense.

EXHIBIT "A"

No. 3263

TRACT 2

Commence at a concrete monument known as marking the Southeast Corner of Section 33, Township 4 North, Range 6 West, Gadsden County, Florida and run thence South 89 degrees 33 minutes 50 seconds West 938.09 feet to the Westerly right of way boundary of Maple Street;

Thence North 26 degrees 27 minutes 20 seconds East along said Westerly right of way boundary 689.31 to the Easterly boundary of property described in Deed Book 91, Page 104 of the Public Records of Gadsden County, Florida for the Point of Beginning;

From said Point of Beginning run North 01 degrees 03 minutes 25 seconds West along said Easterly boundary 113.91 feet to the Southerly boundary of property described in Deed Book 107, Page 4 of the Public Records of Gadsden County, Florida;

Thence South 71 degrees 07 minutes 33 seconds East along said Southerly boundary 53.09 feet to the Westerly right of way boundary of Maple Street;

Thence South 26 degrees 27 minutes 20 seconds West along said Westerly right of way boundary 108.04 feet to the Point of Beginning containing 0.07 acres more or less.

TRACT 3

Begin at the concrete monument known as marking the Southeast corner of Section 33, Township 4 North, Range 6 West, Gadsden County, Florida, and run thence South 89 degrees 33 minutes 50 seconds West 825.97 feet to a concrete monument on the Easterly right of way boundary of Maple Street;

Thence North 26 degrees 27 minutes 20 seconds East along said Easterly right of way boundary, 422.09 feet to the Southerly boundary of property described in Deed Book 91, Page 104 of the Public Records of Gadsden County, Florida;

Thence North 88 degrees 56 minutes 35 seconds East along said Southerly boundary 11.31 feet;

Thence North 01 degrees 03 minutes 25 seconds West along the Easterly boundary of said property 21.73 feet to the Easterly right of way boundary of Maple Street;

Thence North 26 degrees 27 minutes 20 seconds East along said right of way boundary 313.35 feet to the Southerly boundary of property described in Deed Book 107, Page 4 of the Public Records of Gadsden County, Florida;

Thence South 71 degrees 07 minutes 33 seconds East along said Southerly boundary 507.77 feet;

Thence North 01 degrees 16 minutes 33 seconds West along the Easterly boundary of said property 590.50 feet;

Thence North 71 degrees 07 minutes 33 seconds West along the Northerly boundary of said property 231.74 feet to a point on the Easterly right of way boundary of Maple Street, said point lying on a curve concave to the Northwest;

Thence Northeasterly along said right of way boundary and said curve with a radius of 1,491.14 feet through a central angle of 15 degrees 13 minutes 49 seconds for an arc distance of 396.37 feet (the chord of said arc being North 16 degrees 35 minutes 21 seconds East 395.21 feet) to a concrete monument on the Southerly boundary of property described in Official Records Book 131, Page 211 of the Public Records of Gadsden County, Florida;

Thence South 61 degrees 00 minutes 56 seconds East along said Southerly boundary 853.47 feet to a concrete monument, on the Westerly right of way boundary of a Seaboard Coastline Railroad Spur Track;

Thence South 26 degrees 04 minutes 20 seconds West along said Westerly right of way boundary 1,268.99 feet to a concrete monument;

Thence South 89 degrees 33 minutes 50 seconds West 62.34 feet to the Point of Beginning containing 22.61 acres more or less.

33
4N
6W

No. 3263

12. Execution of this agreement in no way affects the lessee's obligations pursuant to Chapter 267, Florida Statutes.

IN TESTIMONY WHEREOF the Trustees, for and on behalf of the Board of Trustees of the Internal Improvement Trust Fund of the State of Florida have hereunto subscribed their names and have caused the official seal of the Board of Trustees of the Internal Improvement Trust Fund of the State of Florida to be hereunto affixed, in the City of Tallahassee, Florida, on the 9th day of September A.D. 1983.



[Signature]
Governor

[Signature]
Secretary of State

[Signature]
Attorney General

[Signature]
Comptroller

[Signature]
Treasurer

[Signature]
Commissioner of Education

[Signature]
Commissioner of Agriculture

APPROVED AS TO
FORM AND LEGALITY

[Signature]
BNR ATTORNEY

As and Constituting the Board of Trustees of the Internal Improvement Trust Fund of the State of Florida

SCHOOL BOARD OF GADSDEN COUNTY

BY: [Signature]
Harold J. Henderson, Chairman

[Signature]
Grinelle E. Bishop, Secretary



FOOTBALL
FIELD

BLDG 7
CONCESSION STAND /
PRESS BOX

BLDG 6
FIELD HOUSE

MAPLE STREET

CHATTAHOOCHEE
SENIOR HIGH SCHOOL

320-001-0001

BLDG
3

BLDG
4

BLDG
1

BLDG 2

BLDG
5

CHATAHOOCHEE HIGH SCHOOL
320-001-0001

BLDG 1

X FIRE EXTINGUISHER
* PULL STATIONS

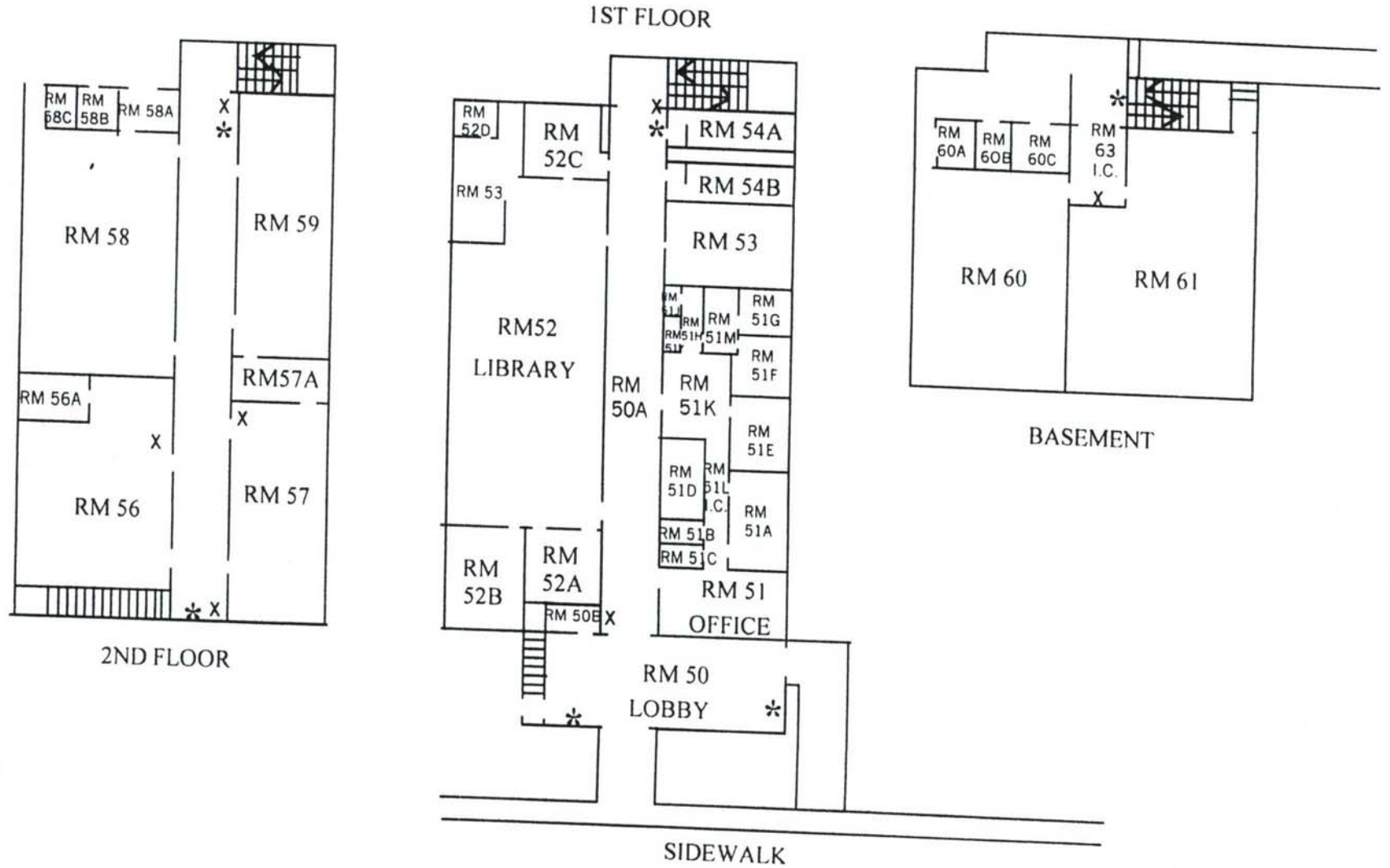

SCALE .50 = 15.0 FEET

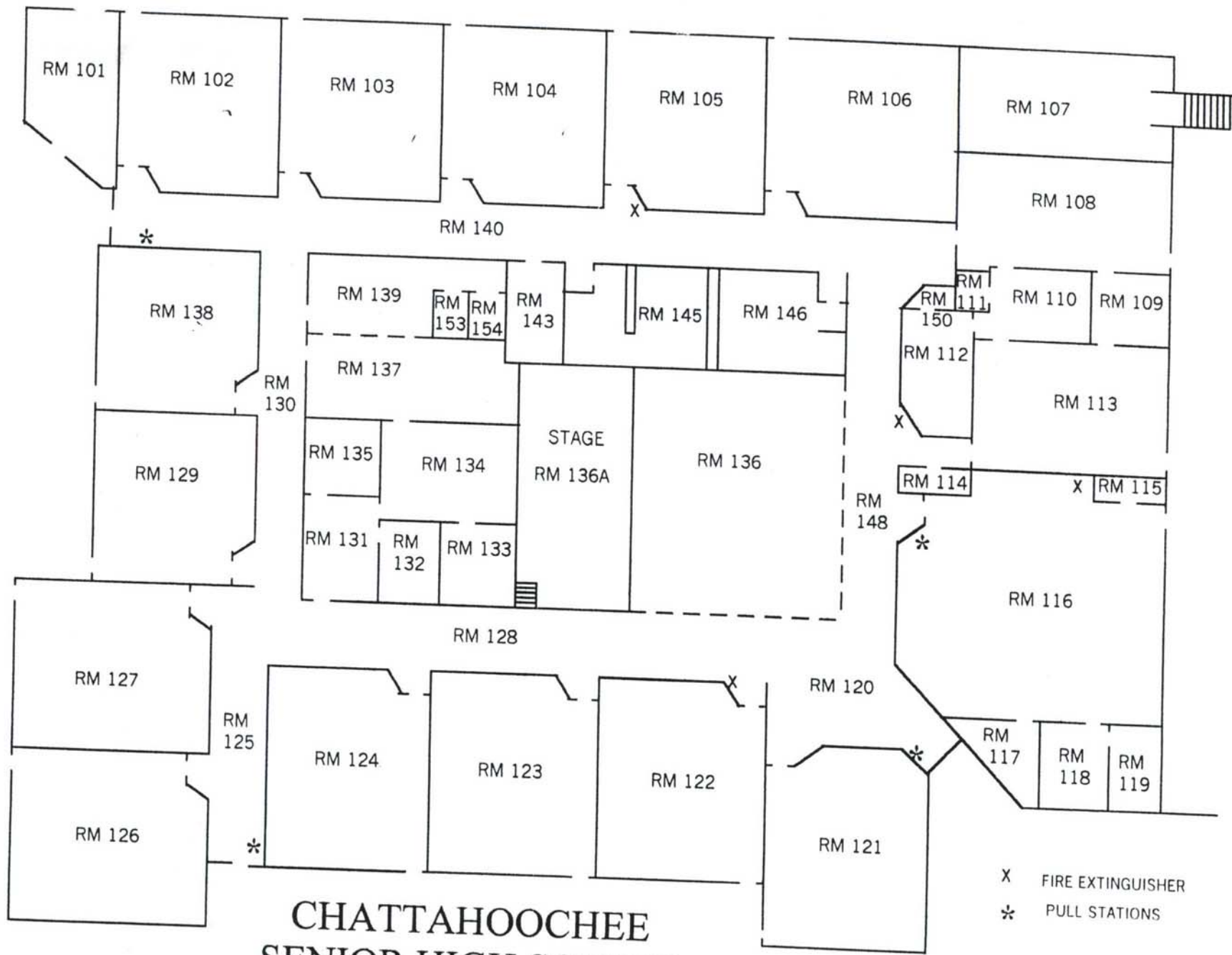

X FIRE EXTINGUISHER
 * PULL STATIONS

**CHATTAHOOCHEE
 SENIOR HIGH SCHOOL**

320-001-0001

BLDG 2

CHATTAHOOCHEE SENIOR HIGH SCHOOL

320-001-0001

BLDG 3

X FIRE EXTINGUISHER
* PULL STATIONS

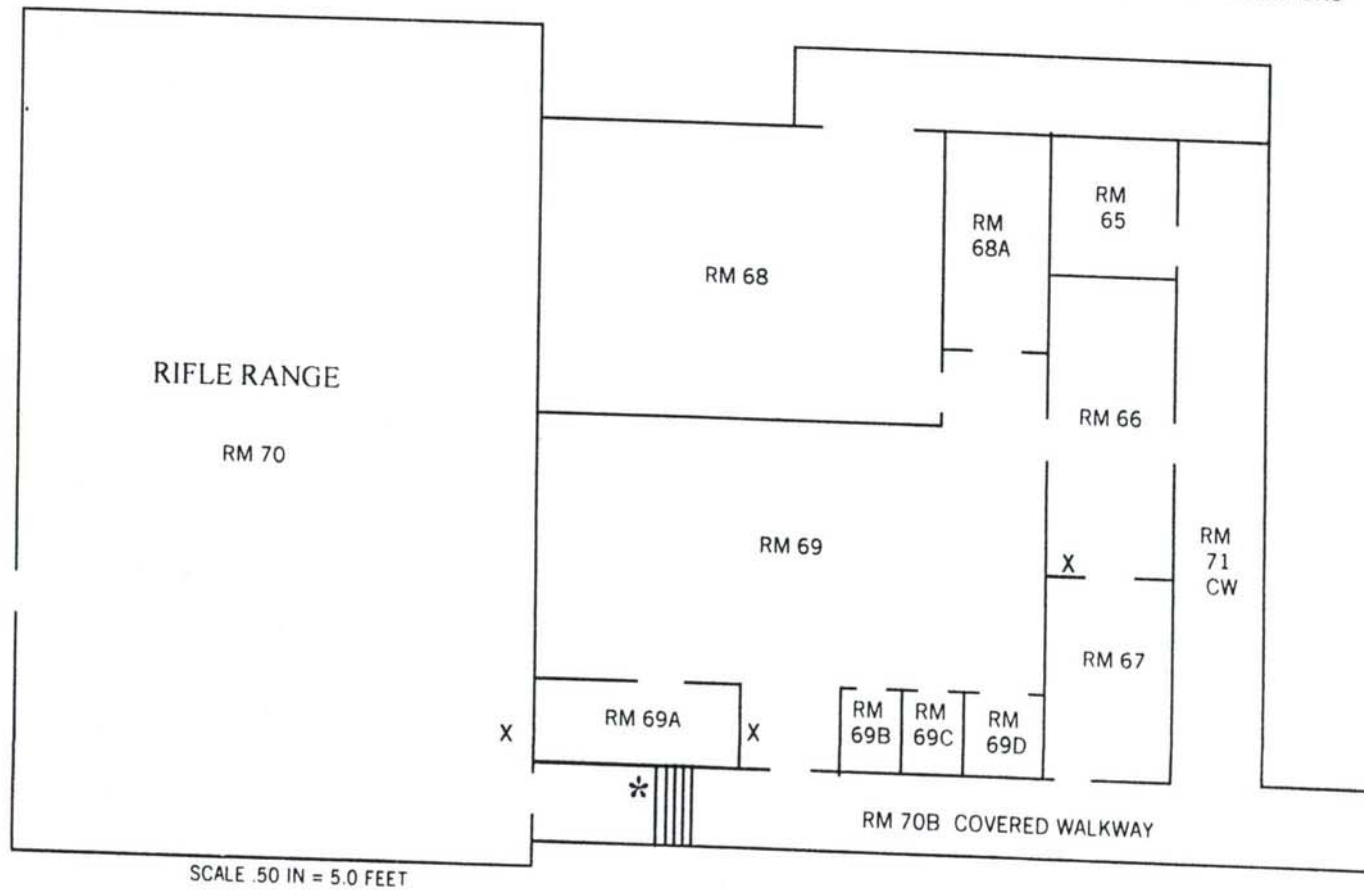

CHATTAHOOCHEE SENIOR HIGH SCHOOL

320-001-0001

BLDG 4

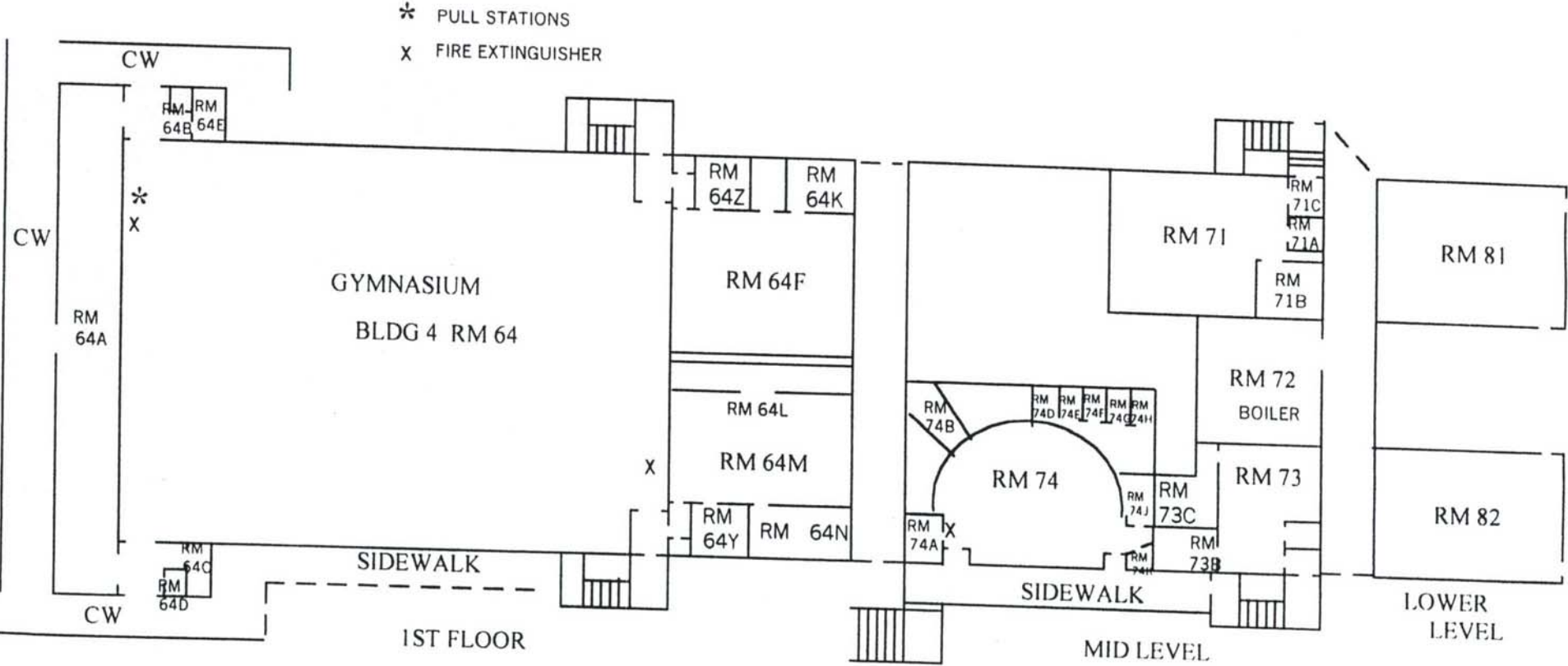

SCALE .50 IN = 15.0 FEET

CHATTAHOOCHEE SENIOR HIGH SCHOOL

320-001-0001

BLDG 5

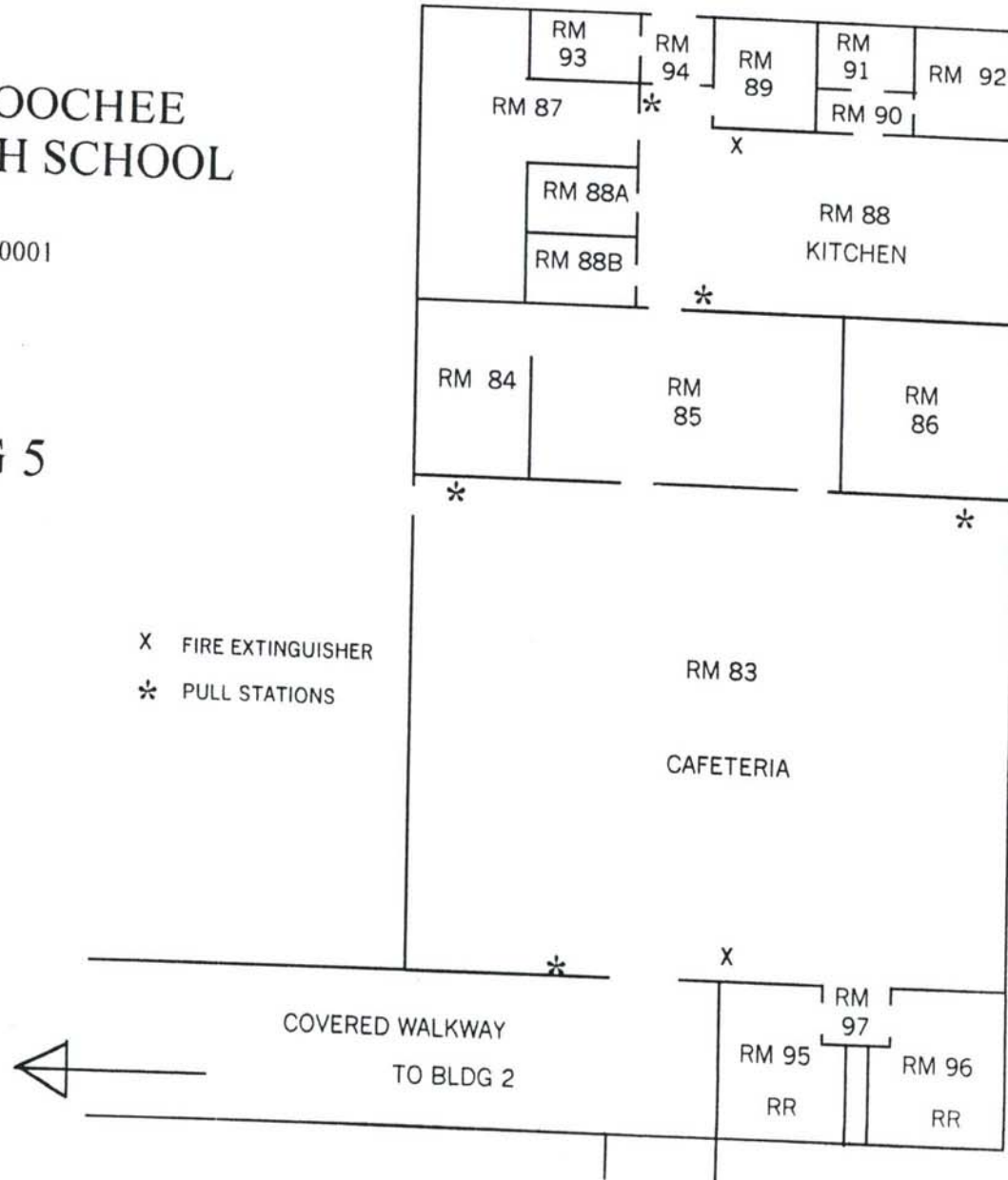

CHATTAHOOCHEE SENIOR HIGH SCHOOL

320-001-0001

BLDG 6

FIELDHOUSE

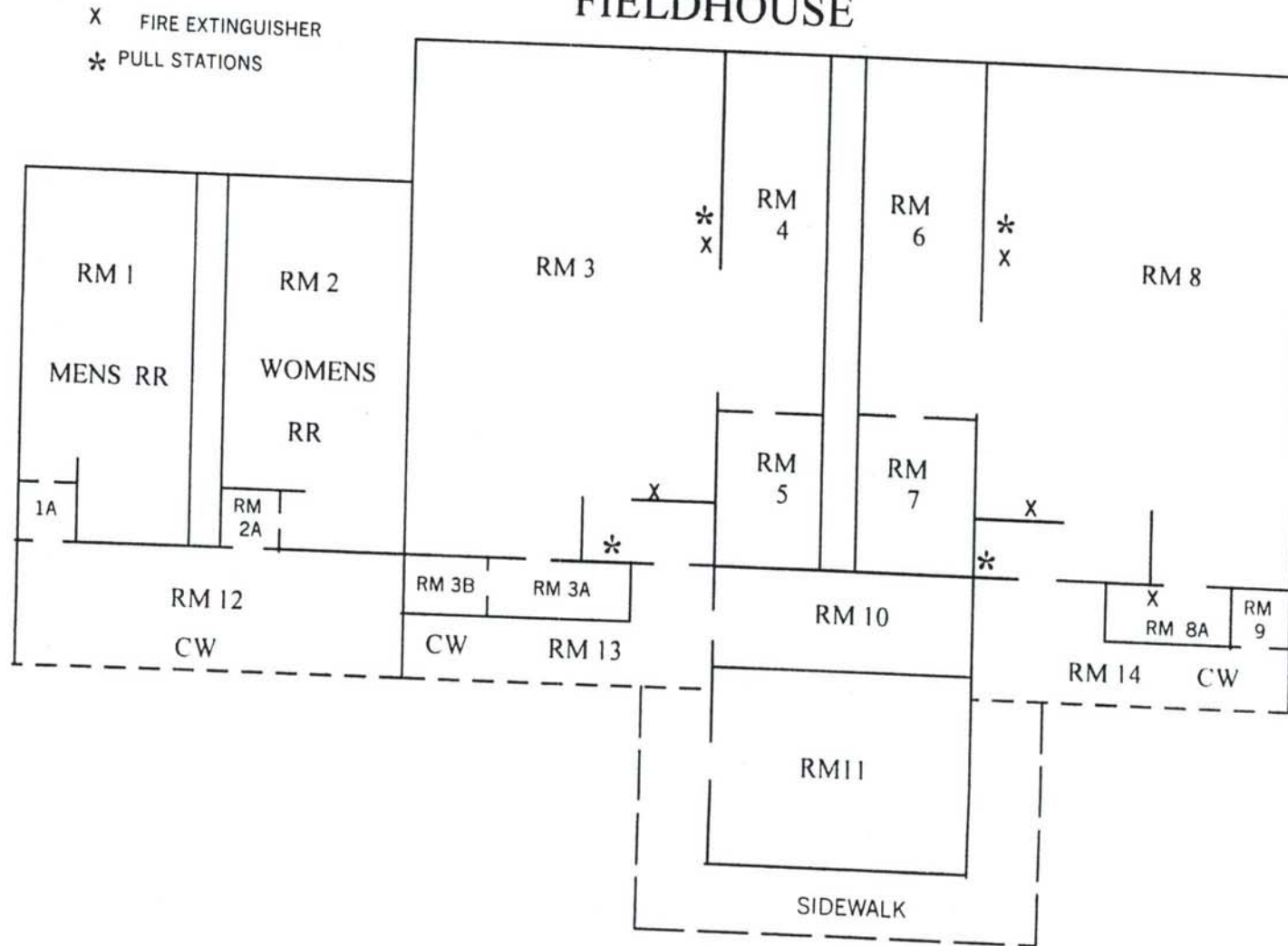

CHATTAHOOCHEE SENIOR HIGH SCHOOL

320-001-0001

BLDG 7

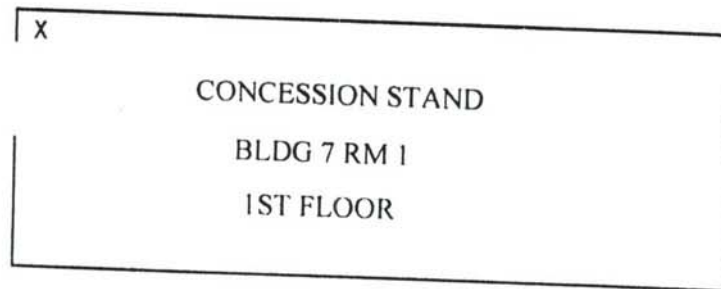

SCALE 1.0 IN = 4.0 FEET

X FIRE EXTINGUISHER

* PULL STATIONS

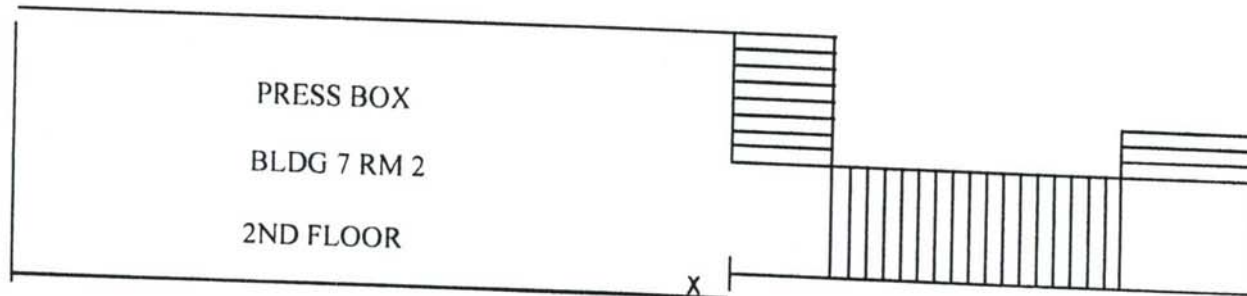

Gadsden County Parcel Maps

Gadsden Home | Map Help | Turn Quick Info On | [Search Page](#)

- Zoom Out
- Zoom In
- Pan by Hand
- Zoom to Box
- Zoom County
- Get Info
- Zoom To Parcel
- Center On Parcel
- Measure
- Area Tool
- Print Page
- Search Sales

- Show:
- Parcels
 - Roads
 - Lakes & Rivers
 - Railroads
 - Yearly Sales
 - Parcel Numbers
 - Lots
 - Dimensions
 - Sec-Twn-Rng
 - Future Land Use
 - Aerial Photography



1:6,634



Report Legend

PARCEL INFORMATION TABLE			
Selected Parcel	3-17-2N-5W-0000-00223-0100 (Click for Complete Card)		
DOR Property Usage	SCHOOLS, PUBLIC (83)		
Acres	11		
Property Use	PUBLIC SCH		
Land Use	SCHOOL		
OWNERSHIP INFORMATION			
Name	SCHOOL BOARD OF GADSDEN COUNTY		
Mailing Address	GREENSBORO ELEMENTARY 35 MARTIN LUTHER KING BLVD; QUINCY, FL 32351		
Situs/Physical Address	62 LONNIE CLARK RD		
VALUES			
Land Value	31,900		
Ag Land Value	0		
Building Value	0		
Misc Value	690,679		
Just Value	722,579		
Assessed Value	722,579		
Exempt Value	722,579		
Taxable Value	0		
Homestead?	N		
LAST 2 SALES			
Date	Price	Vacant?	Qual

The Gadsden County Property Appraiser's Office makes every effort to produce the most accurate information possible. No warranties, expressed or implied, are provided for the data herein, its use or interpretation. The assessment information is from the last certified taxroll. All data is subject to change before the next certified taxroll. PLEASE NOTE THAT THE PROPERTY APPRAISER MAPS ARE FOR ASSESSMENT PURPOSES ONLY NEITHER GADSDEN COUNTY NOR ITS EMPLOYEES ASSUME RESPONSIBILITY FOR ERRORS OR OMISSIONS ---THIS IS NOT A SURVEY---

[Gadsden Home](#) ----- [Search Page](#)
© Website design by [qpublic.net](#)

GREENSBORO ELEMENTARY SCHOOL

320-008-0008

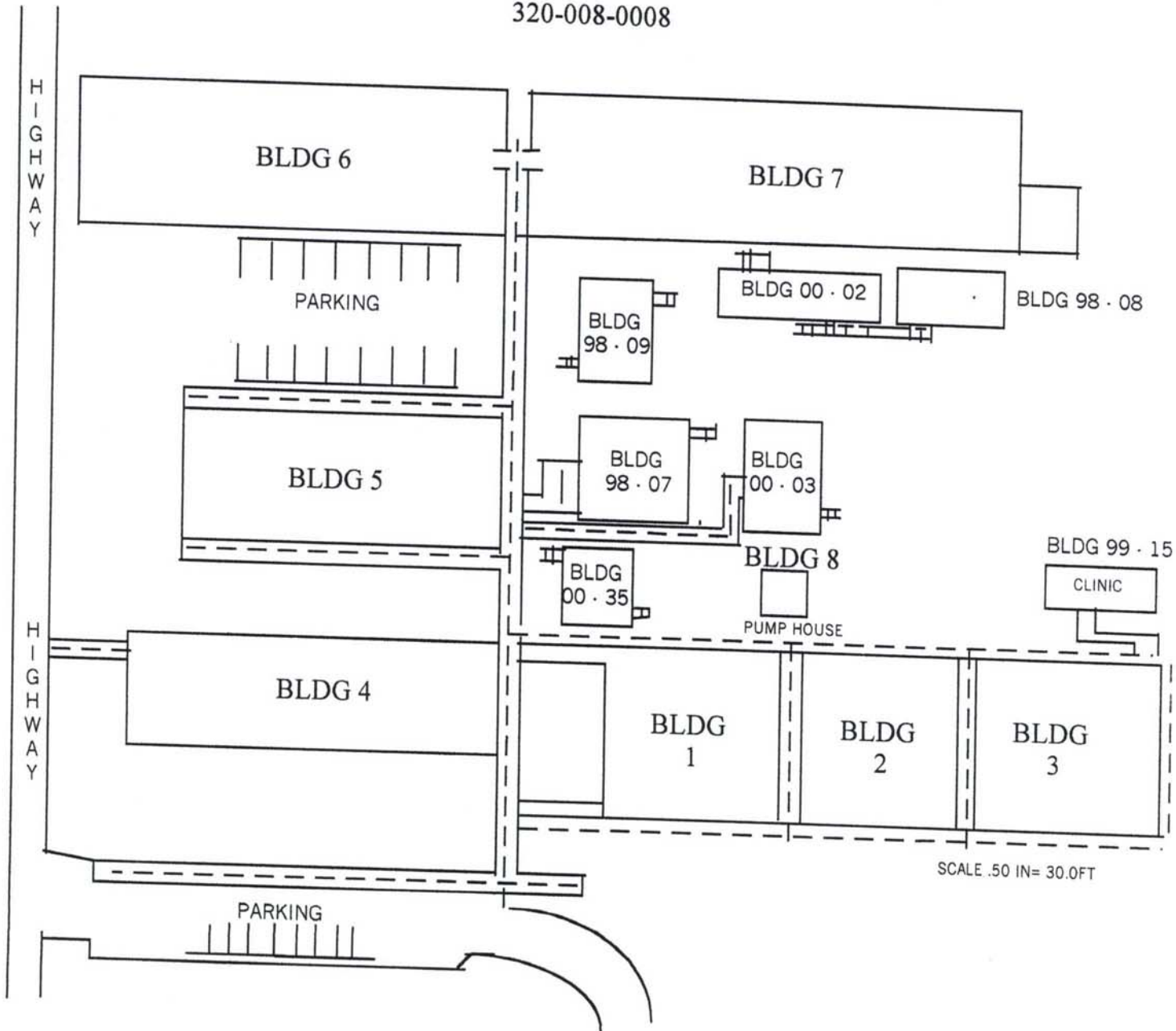

GREENSBORO ELEMENTARY SCHOOL

320-008-0008

BLDG 1, 2, 3

x = FIRE EXTINGUISHER

* = PULL STATION

(buildings are facing the street)

BLDG 3

BLDG 2

BLDG 1

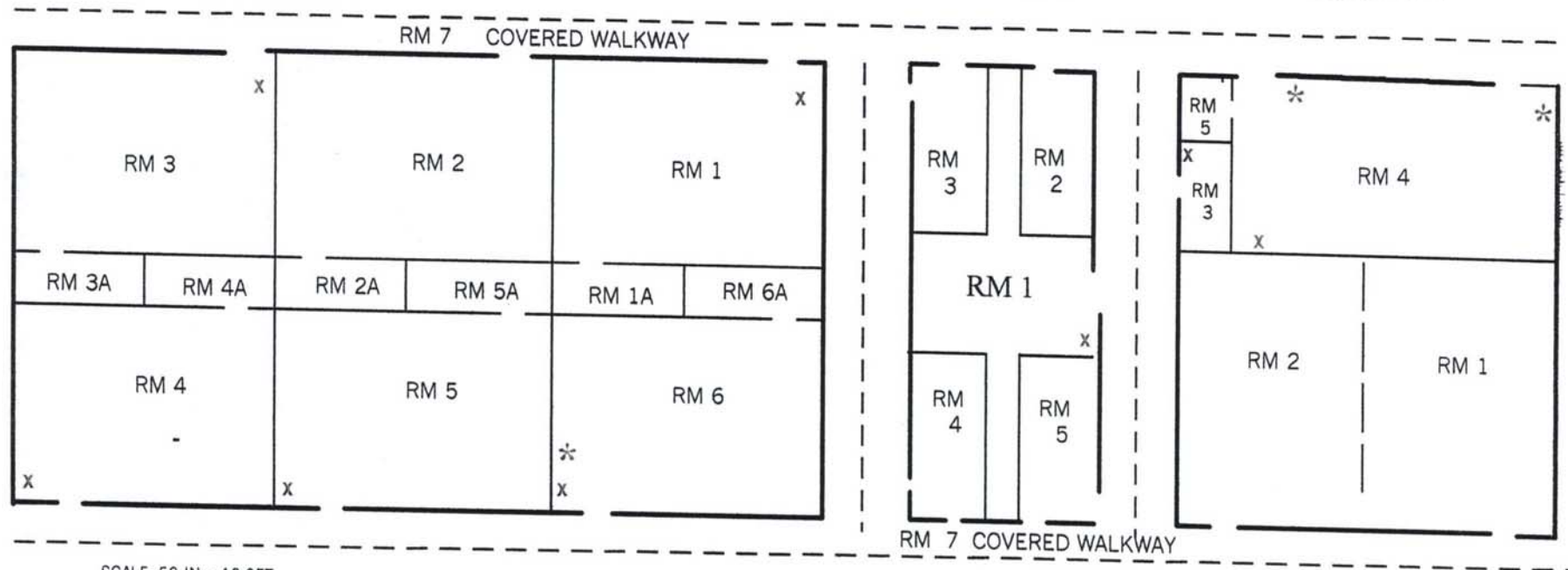

SCALE .50 IN = 10.0FT

PUMP HOUSE

GREENSBORO ELEMENTARY SCHOOL

320-008-0008

BLDG 4

5
6
C
O
V
E
R
E
D
W
A
L
K

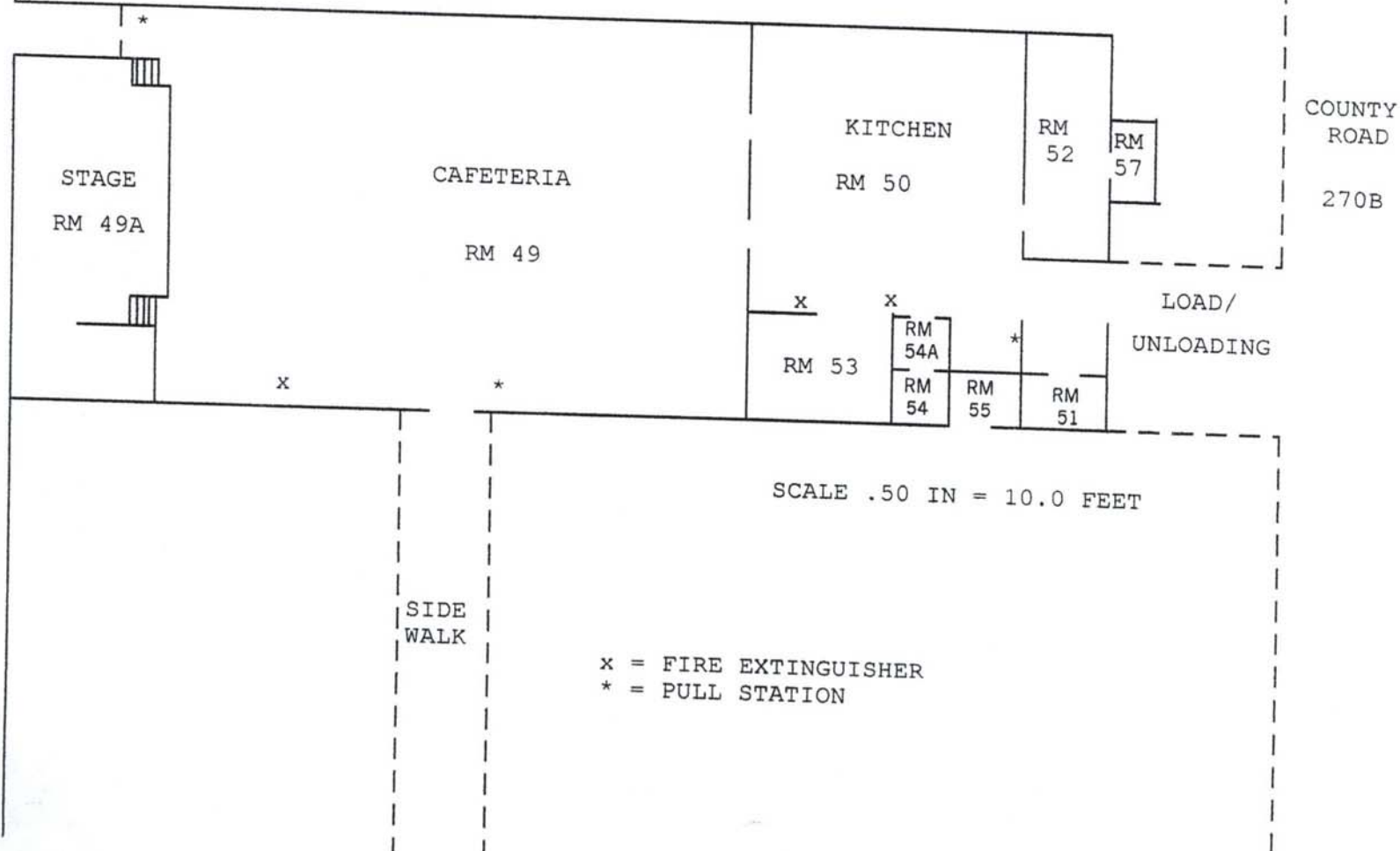

GREENSBORO ELEMENTARY SCHOOL

320-008-0008

BLDG 5

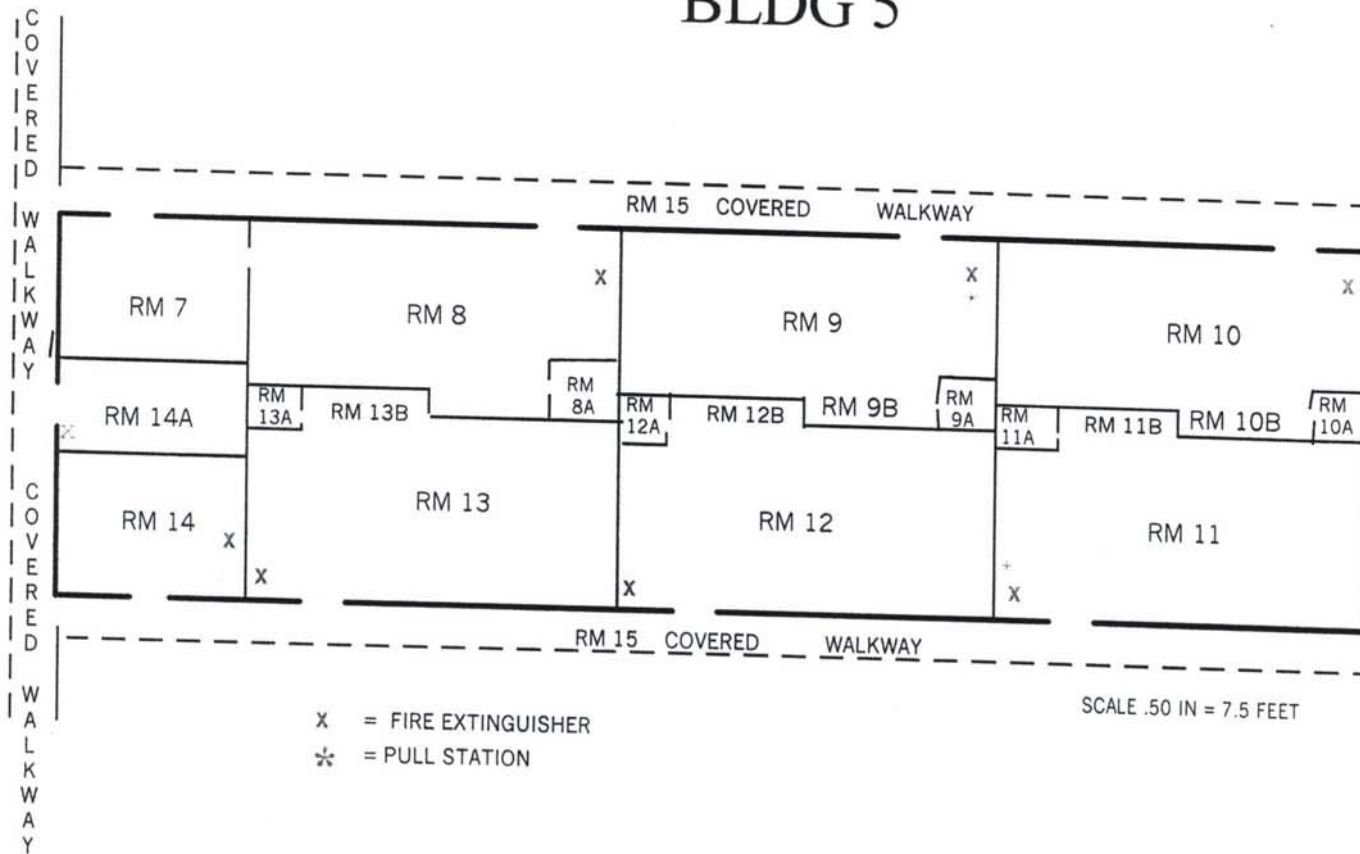

GREENSBORO ELEMENTARY SCHOOL

320-008-0008

BLDG 6

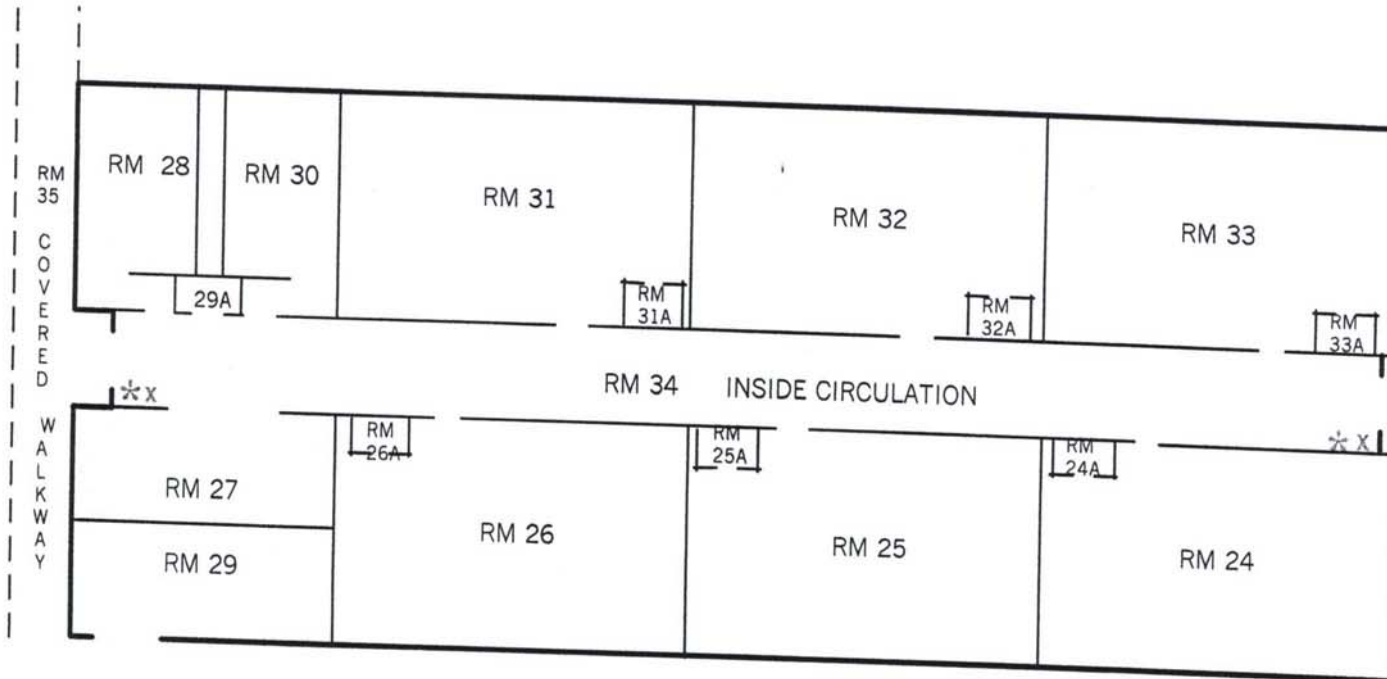

* = PULL STATION x = FIRE EXTINGUISHER

SCALE .50 IN = 7.5 FEET

GREENSBORO ELEMENTARY SCHOOL

320-008-0008

BLDG 7

X = FIRE EXTINGUISHER

* = PULL STATION

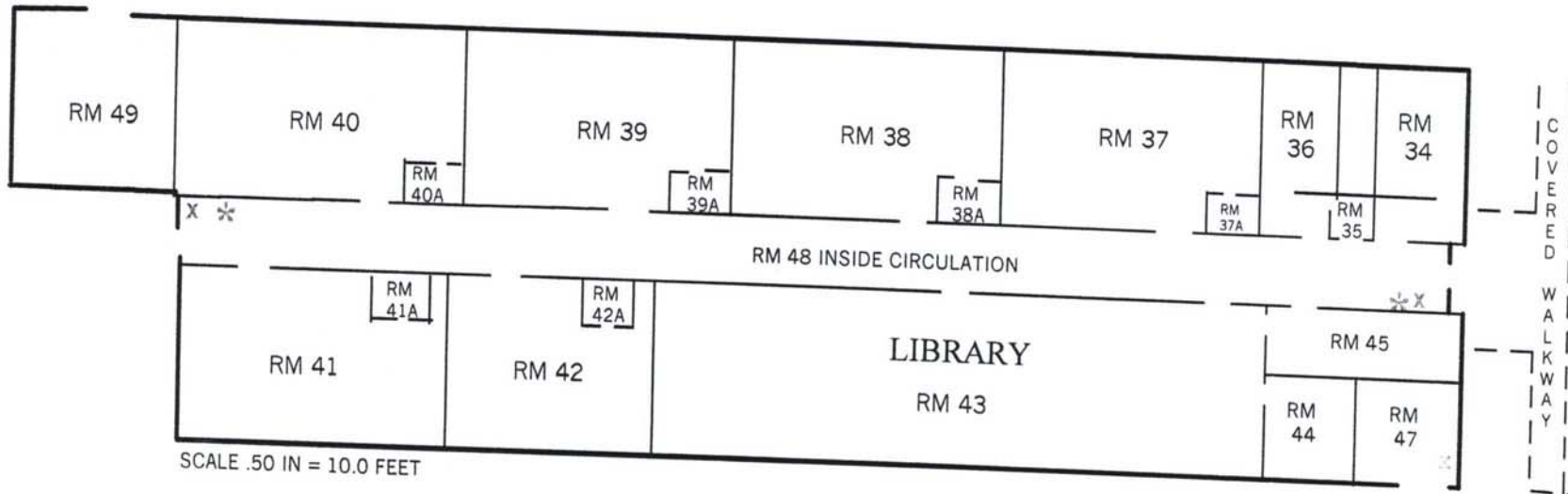

GREENSBORO ELEMENTARY
SCHOOL

320-008-0008

BLDG 8

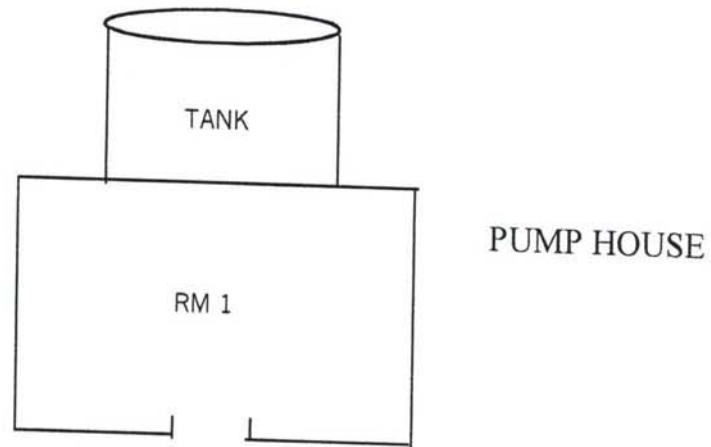

Gadsden County Parcel Maps

[Gadsden Home](#) | [Map Help](#) | [Turn Quick Info On](#) | [Search Page](#)

- Zoom Out
- Zoom In
- Panby Hand
- Zoom to Box
- Zoom County
- Get Info
- Zoom To Parcel
- Center On Parcel
- Measure
- Area Tool
- Print Page
- Search Sales

- Show:**
- Parcels
 - Roads
 - Lakes & Rivers
 - Railroads
 - Yearly Sales
 - Parcel Numbers
 - Lots
 - Dimensions
 - Sec-Twn-Rng
 - Future Land Use
 - Aerial Photography



1:7,351



[Report](#) [Legend](#)

PARCEL INFORMATION TABLE			
Selected Parcel	2-26-3N-2W-0210-0000E-0010 <small>(Click for Complete Card)</small>		
DOR Property Usage	SCHOOLS, PUBLIC (83)		
Acres	0		
Property Use	PUBLIC SCH		
Land Use	SCHOOL		
OWNERSHIP INFORMATION			
Name	SCHOOL BOARD OF GADSDEN COUNTY		
Mailing Address	COUNTY FLA HAVANA NORTHSIDE HIGH SCHOOL; 35 MARTIN LUTHER KING BLVD QUINCY, FL 32351		
Situs/Physical Address	264 CARVER AVE		
VALUES			
Land Value	201,110		
Ag Land Value	0		
Building Value	0		
Misc Value	1,248,000		
Just Value	1,449,110		
Assessed Value	1,449,110		
Exempt Value	1,449,110		
Taxable Value	0		
Homestead?	N		
LAST 2 SALES			
Date	Price	Vacant?	Qual

The Gadsden County Property Appraiser's Office makes every effort to produce the most accurate information possible. No warranties, expressed or implied, are provided for the data herein, its use or interpretation. The assessment information is from the last certified taxroll. All data is subject to change before the next certified taxroll. PLEASE NOTE THAT THE PROPERTY APPRAISER MAPS ARE FOR ASSESSMENT PURPOSES ONLY NEITHER GADSDEN COUNTY NOR ITS EMPLOYEES ASSUME RESPONSIBILITY FOR ERRORS OR OMISSIONS ---THIS IS NOT A SURVEY---

[Gadsden Home](#) [Search Page](#)
© Website design by [qpublic.net](#)

NOTE: The football field area is currently leased to the State of Florida. This lease agreement is attached and numbered 3110.

STATE OF FLORIDA
BOARD OF TRUSTEES OF THE INTERNAL IMPROVEMENT TRUST FUND

LEASE AGREEMENT

(1) 3110

No. 3110

WHEREAS, Board of Trustees of the Internal Improvement Trust Fund holds title to certain lands and property being utilized by the State of Florida for public purposes, and

WHEREAS, Board of Trustees of the Internal Improvement Trust Fund is authorized in Section 253.03, Florida Statutes, to enter into leases for the use, benefit and possession of public lands by State agencies which may properly use and possess them for the benefit of the State;

NOW, THEREFORE, this agreement made between BOARD OF TRUSTEES OF THE INTERNAL IMPROVEMENT TRUST FUND, DEPARTMENT OF NATURAL RESOURCES, DIVISION OF RESOURCE MANAGEMENT, as LESSOR, and THE SCHOOL BOARD OF GADSDEN COUNTY, FLORIDA, as LESSEE.

WITNESSETH:

The parties, for and in consideration of mutual covenants and agreements hereinafter contained, hereby covenant and agree as follows:

1. The lessor does hereby lease to the lessee the following described premises in the County of Gadsden, State of Florida, together with the improvements thereon (if applicable), viz:

(Exhibit A - attached)

TO HAVE AND TO HOLD the above described land for a period of Fifty (50) years for public school purposes.

2. The lessee shall have the right to enter upon said land for all purposes necessary to the full enjoyment by said lessee of the rights herein conveyed to it.

3. The lessee shall through its agents and employees prevent the unauthorized use of said land or any use thereof not in conformity with this lease.

No. 3110

4. This lease shall terminate at the sole option of the lessor, and the lessee shall surrender up the premises to the lessor, when and if said premises, including lands and improvements, shall cease to be used for public school purposes.

Any costs arising out of the enforcement of the terms of this lease agreement shall be the exclusive obligation of the lessee, payable upon demand of the lessor.

5. The lessee hereby covenants and agrees to investigate all claims of every nature at its own expense and to indemnify, protect, defend, hold and save harmless the lessor from any and all claims, actions, lawsuits and demands of any kind or nature arising out of this agreement to the extent allowable by law.

6. The lessor does not warrant or guarantee title, right or interest in the hereinabove described property.

7. The lessor or its duly authorized agents shall have the right at any time to inspect the said land and the works and operations thereon of the lessee in any matter pertaining to this agreement.

8. The lessee agrees to assume all responsibility for liabilities that accrue to the subject property or to the improvements thereon, including any and all drainage or special assessments or taxes of every kind and description which are now or may be hereafter lawfully assessed and levied against the subject property during the effective period of this lease.

9. The lessee is hereby authorized to grant utility easements which will be necessary to service authorized facilities located within the leased premises. Copies of any such easements granted shall be filed timely with the lessor.

10. This agreement is for the purposes specified herein, and subleases of any nature, excepting utility easements incident to authorized facilities, (Provision 9), are prohibited, unless previously authorized by the lessor.

No. 3110

11. Upon cessation of occupation of said property, the lessee agrees to leave all fixed improvements for the use of the lessor and to put no claim upon said fixed improvements; or, at the option of the lessor, the lessee agrees to remove any or all improvements on the property at the lessee's expense.

12. Execution of this agreement in no way affects the lessee's obligations pursuant to Chapter 267, Florida Statutes.

IN TESTIMONY WHEREOF, the legally designated agent of the Board of Trustees of the Internal Improvement Trust Fund has hereunto subscribed his name and has caused the official seal of the Board of Trustees of the Internal Improvement Trust Fund to be hereunto affixed, in the City of Tallahassee, Florida, on this the 21st day of June, A. D. 19 79



BY THE AUTHORITY VESTED IN ME
BY THE GOVERNOR AND CABINET
JANUARY 26, 1979

APPROVED AS TO
FORM AND LEGALITY

[Signature]
ATTORNEY - D.N.R.

BOARD OF TRUSTEES OF THE INTERNAL
IMPROVEMENT TRUST FUND OF THE STATE
OF FLORIDA

By [Signature]
Interim Executive Director, Department of
Natural Resources,
Agent for the Board of Trustees of
the Internal Improvement Trust Fund
authorized to execute this instrument
for and on its behalf pursuant to
Section 253.431, Florida Statutes,
and resolution recorded in its min-
utes of November 4, 1975.

THE SCHOOL BOARD OF GADSDEN COUNTY,
FLORIDA

BY: [Signature]

Chairman

Date: June 13, 1979

EXHIBIT A

A parcel of land lying and being in Sections 22 and 23, Township 3 North, Range 2 West, Gadsden County, Florida, being more particularly described as follows:

Begin at a concrete monument (found) known as marking the Southwest Corner of said Section 23; also said concrete monument being East 13.08 feet from the Northeast Corner of Lot 40, Block "I" of HAMPTON HEIGHTS, a subdivision as per map or plat thereof recorded in the public records of said county, and run thence East along the Northerly boundary of said Block "I" a distance of 443.57 feet; thence North 710.53 feet; thence West 661.86 feet; thence South 140.53 feet; thence West 814.17 feet to a point of curve to the right; thence Northwesterly along said curve with a radius of 50.93 feet through a central angle of 97 degrees 55 minutes 12 seconds for an arc distance of 87.05 feet (the chord of said arc being North 41 degrees 02 minutes 24 seconds West 76.83 feet) to a Department of Transportation concrete monument for the end of said curve, also said point lying on the Easterly right of way boundary of State Road No. 63 (Highway 27); thence South 07 degrees 55 minutes 12 seconds West along said Easterly right of way boundary 163.42 feet to a point of curve, concave to the Southeast; thence Northeasterly along said curve with a radius of 50.93 feet through a central angle of 82 degrees 04 minutes 48 seconds for an arc distance of 72.96 feet (the chord of said arc being North 48 degrees 57 minutes 36 seconds East 66.88 feet) to the end of said curve; thence East 836.70 feet; thence South 300.00 feet; thence West 865.33 feet to a point of curve to the right; thence Northwesterly along said curve with a radius of 50.00 feet through a central angle of 97 degrees 55 minutes 12 seconds for an arc distance of 85.45 feet (the chord of said arc being North 41 degrees 02 minutes 24 seconds West 75.42 feet) to a point for the end of said curve, also said point lying on said Easterly right of way boundary; thence South 07 degrees 55 minutes 12 seconds West along said Easterly right of way boundary 161.55 feet to a point of curve, concave to the Southeast; thence Northeasterly along said curve with a radius of 50.00 feet through a central angle of 82 degrees 04 minutes 48 seconds for an arc distance of 71.63 feet (the chord of said arc being North 48 degrees 57 minutes 36 seconds East 65.66 feet) to the end of the said curve; thence East 887.58 feet; thence South 150.00 feet to said Northerly boundary of Block "I"; thence East along said Northerly boundary 218.29 feet to the Point of Beginning, containing 13.33 acres, more or less.

BLDG 4
CONCESSIONS

BLDG 5
PRESS BOX

BLDG 6
FIELDHOUSE

BLDG
99 - 37
WEIGHT ROOM

BLDG 3
TICKET BOOTH

HAVANA NORTHSIDE HIGH SCHOOL

320-005-0005

S
T
R
E
E
T

I
N

F
R
O
N
T

O
F

S
C
H
O
O
L

LIBRARY

BLDG 1

OFFICE

BLDG
99 - 43

BLDG
99 - 44

BLDG
99 - 45

BLDG 1

CAFETERIA

GYM

BLDG 2

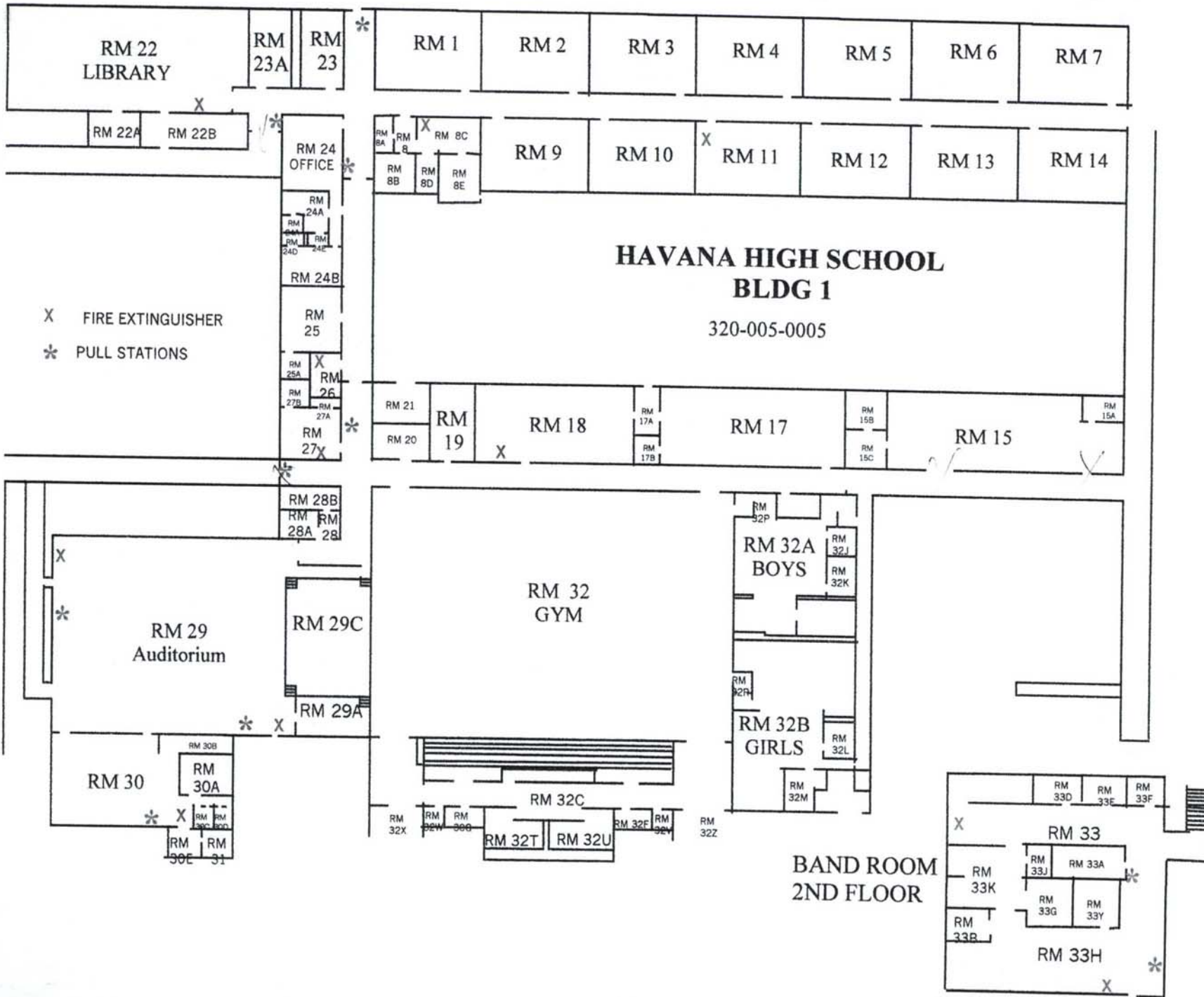

HAVANA NORTHSIDE HIGH SCHOOL

320-005-0005

BLDG 2

- X FIRE EXTINGUISHER
- * PULL STATIONS

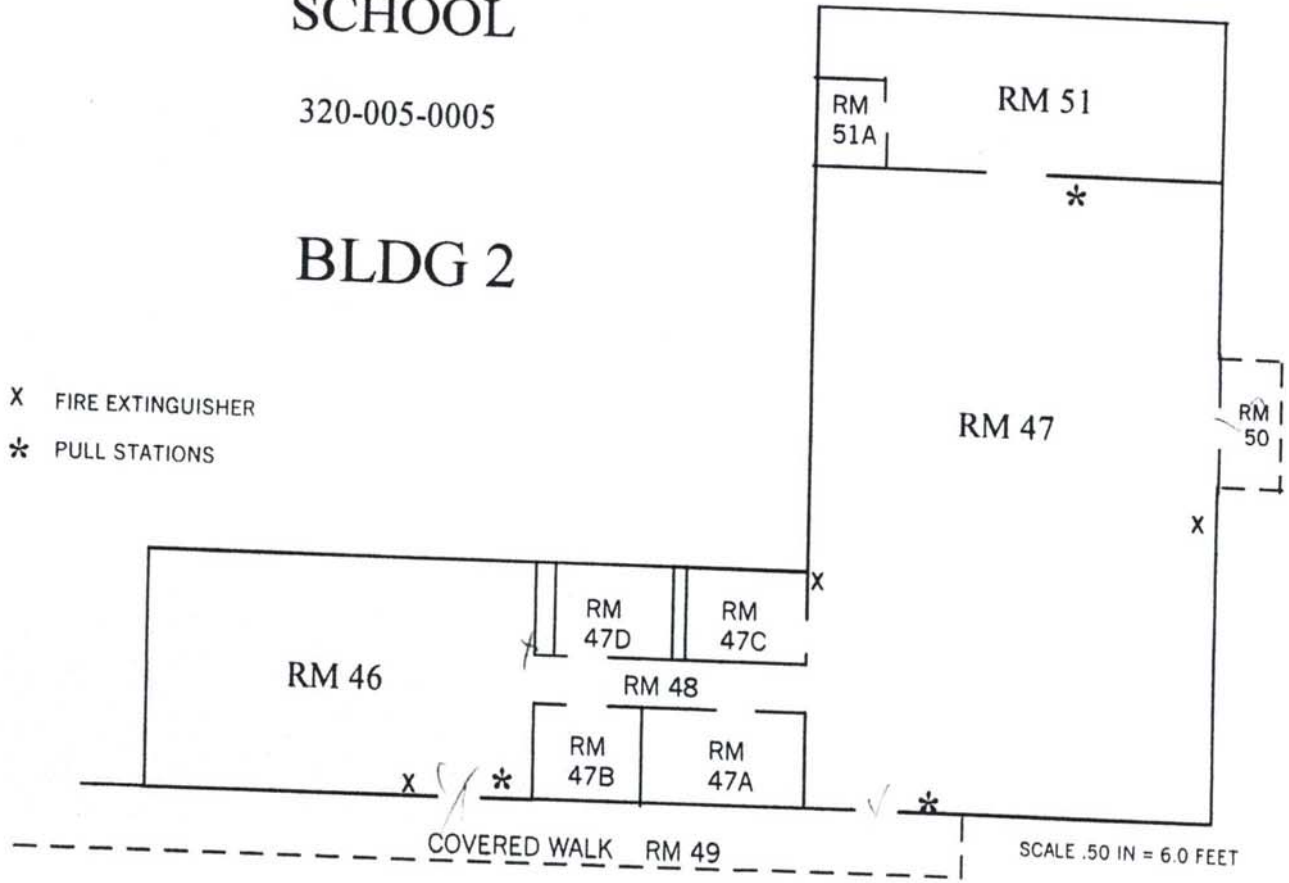

HAVANA NORTHSIDE HIGH SCHOOL

320-005-0005

BLDGS 3, 4

BLDG 4

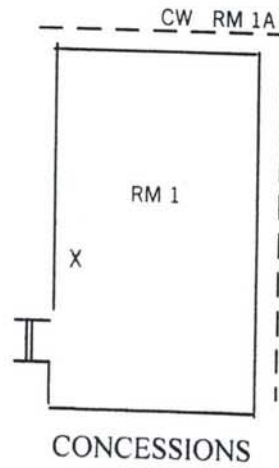

BLDG 3

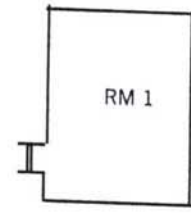

X FIRE EXTINGUISHER

* PULL STATIONS

HAVANA NORTHSIDE HIGH SCHOOL

320-005-0005

BLDG 5

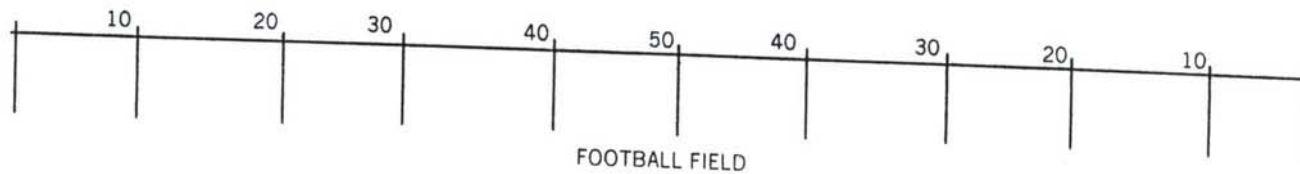
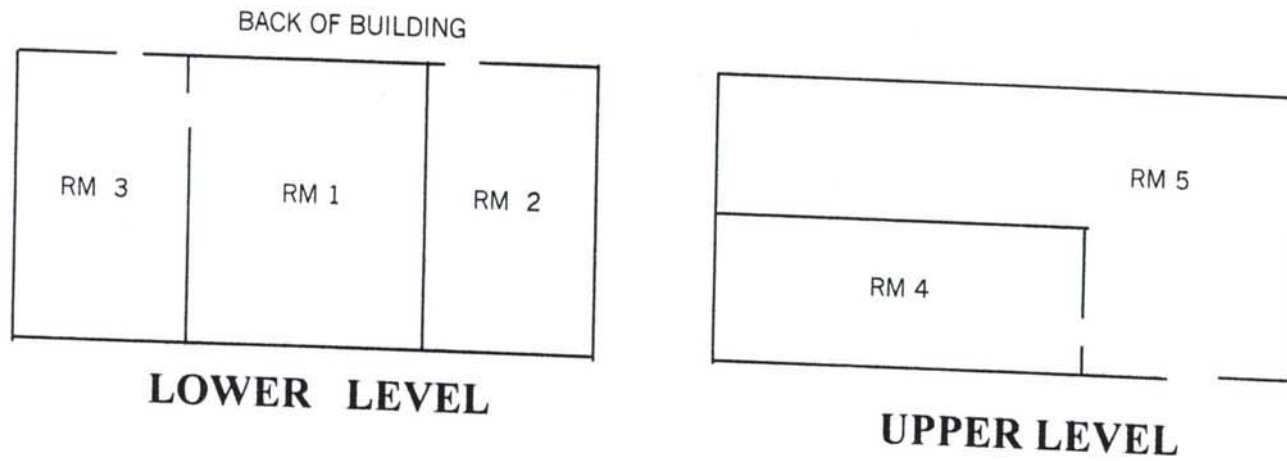

HAVANA HIGH SCHOOL

320-005-0005

BLDG 6

FIELDHOUSE

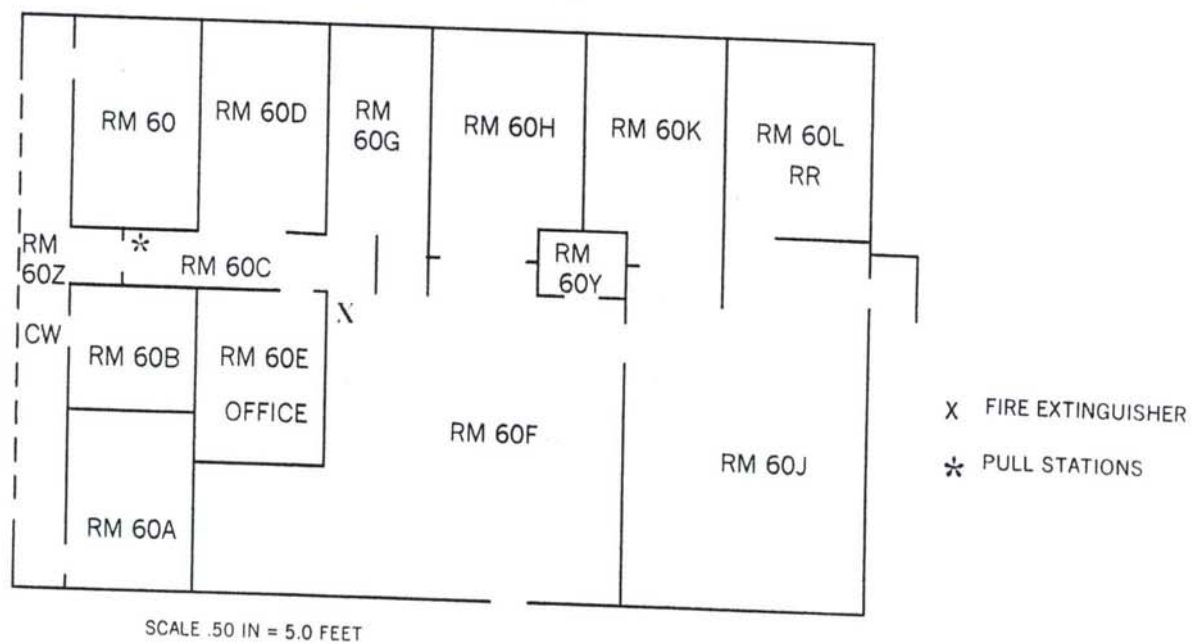

Gadsden County Parcel Maps

[Gadsden Home](#) | [Map Help](#) | [Turn Quick Info On](#) | [Search Page](#)

- Zoom Out
- Zoom In
- Pan by Hand
- Zoom to Box
- Zoom County
- Get Info
- Zoom To Parcel
- Center On Parcel
- Measure
- Area Tool
- Print Page
- Search Sales

- Show:**
- Parcels
 - Roads
 - Lakes & Rivers
 - Railroads
 - Yearly Sales
 - Parcel Numbers
 - Lots
 - Dimensions
 - Sec-Twn-Rng
 - Future Land Use
 - Aerial Photography



Report Legend

PARCEL INFORMATION TABLE			
Selected Parcel	4-08-1N-2W-0000-00300-0300 (Click for Complete Card)		
DOR Property Usage	SCHOOLS, PUBLIC (83)		
Acres	25		
Property Use	PUBLIC SCH		
Land Use	SCHOOL		
OWNERSHIP INFORMATION			
Name	SCHOOL BOARD OF GADSDEN COUNTY		
Mailing Address	MIDWAY - MCLAIN 35 MARTIN LUTHER KING BLVD; QUINCY, FL 32351		
Situs/Physical Address	.		
VALUES			
Land Value	150,000		
Ag Land Value	0		
Building Value	0		
Misc Value	0		
Just Value	150,000		
Assessed Value	150,000		
Exempt Value	150,000		
Taxable Value	0		
Homestead?	N		
LAST 2 SALES			
Date	Price	Vacant?	Qual
12-1996	100	Y	U

1:7,840

The Gadsden County Property Appraiser's Office makes every effort to produce the most accurate information possible. No warranties, expressed or implied, are provided for the data herein, its use or interpretation. The assessment information is from the last certified taxroll. All data is subject to change before the next certified taxroll. PLEASE NOTE THAT THE PROPERTY APPRAISER MAPS ARE FOR ASSESSMENT PURPOSES ONLY NEITHER GADSDEN COUNTY NOR ITS EMPLOYEES ASSUME RESPONSIBILITY FOR ERRORS OR OMISSIONS ---THIS IS NOT A SURVEY---

[Gadsden Home](#) ----- [Search Page](#)

© Website design by [qpublic.net](#)

NOTE: On December 15, 2009, five acres of the total twenty-five acres was leased to Midway Unity Fellowship, Inc.

LEASE

THIS AGREEMENT made this 15th day of December, 2009, between the School Board of Gadsden County, Florida hereinafter called the Lessor, and Midway Unity Fellowship, Inc., hereinafter called the Lessee, each in consideration of the agreements to be performed by the other, hereby agree as follows:

1. LEASED PREMISES; TERM: The Lessor hereby leases to the Lessee five (5) acres of unimproved land located at Mine Road, Midway, Florida together with the right of the Lessee, its invitees and customers to use the adjacent parking area, all being a part of the following described real property:

See attachment "A"

for the term beginning on January 1, 2010 extending for a period of three (3) years. Lessee will have the option to renew the lease by notifying Lessor within 60 days of the expiration of the then current lease period. All agreements to extend the lease must be in writing.

2. RENTAL RATE. The Lessee will pay to the Lessor, as rent for the property annual rental in the amount of \$4,800.00 in monthly installments of \$400.00, plus all applicable rental tax due thereon. All applicable rental tax shall be paid monthly by the Lessee directly to Lessor, who will remit said taxes to the State Department of Revenue. All rental amounts are due on the first day of each month, and shall be in default if not paid by the 10th day of the month due. The first and last month's rent shall be paid at the time of execution of this lease, with the base term beginning to run 30 days after possession is delivered to Lessee by Lessor.

3. LATE CHARGES AND RETURNED CHECKS: The Monthly Rental due Lessor under this lease shall be considered past due for purposes of this Lease if not received by Lessor by the fifth (5th) day of any month during the lease Term. If Lessor has received any Monthly Rental payment required by this Lease by the fifth (5th) day of the month it is due, Lessee shall, in addition to the Monthly Rental payment, be obligated to and shall pay a service charge of \$0.00. Any other amounts payable to Lessor under this Lease, with the exception of Monthly Rental, shall be considered past due 30 days from Lessor's billing date and, in addition to such payment, Lessee shall pay interest on such past due payment at the Default Rate of the legal rate set by law for judgments and decrees until it is, or they are, paid. Any check received from Lessee which is returned for insufficient funds or any other reason shall require Lessee to pay Lessor a service charge of \$35.00 per returned check.

4. INSURANCE; CASUALTY. The Lessee shall procure and pay for a comprehensive general liability insurance policy in at least the amount of \$500,000.00 total coverage protecting the Lessor and Lessee against any claims for property damage, wrongful death or personal injury. Proof of such policy shall be furnished

annually by Lessee to Lessor. Except for damages proximately caused by Lessor's negligence or willful misconduct, Lessee hereby further indemnifies and holds harmless the Lessor against any and all liability or damages, attorney's fees and court costs due to property damages, wrongful death or persona injury on the leased premises. Lessee shall pay for fire insurance on the building. Each party hereby releases the other from liability for any loss or damage of the type covered by fire insurance with extended coverage and grants to the other party, on behalf of any insurer providing such insurance, a waiver of any right of subrogation which any such insurer of either party may require against the other party hereto by virtue of payment of loss covered by such insurance.

5. PERMITTED USE. Lessee may use and occupy the leased premises only for the purpose of operating a location to assist students and parents in transitioning back into the educational system and community. No other use shall be allowed. Lessee shall not use or knowingly permit any part of the premises to be used for an unlawful purpose. It is understood and agreed between the parties that if the Lessee's use and occupancy of the leased premises becomes prohibited or substantially impaired by reason of any zoning law, ordinance or regulation of federal, state, county or municipal governments, by reason any act of legal or governmental or other public authority then this lease shall terminate as of the date of such act or law as set forth herein or at Lessee's election the lease shall continue and all rent and other charges shall abate during such time that Lessee's use or occupancy of the leased premises is prohibited or substantially impaired.

6. ASSIGNMENTS. This lease is not assignable by Lessee.

7. CONSTRUCTION; FIXTURES. Lessee contemplates locating a portable building on the above-described premises. Lessee shall be responsible for all costs associated with the location of the portable and any maintenance or repairs made thereto. Any plans and specifications for other improvements to premises leased hereunder must be submitted to Lessor for Lessor's written approval, and no construction shall commence until Lessor approves said plans and specifications. Any such improvements shall become property of Lessor upon expiration of this lease. By taking possession of the premises, Lessee shall accept and shall be held to have accepted the premises as suitable for the use intended by Lessee. Lessor shall not be required, after delivery of possession, to make any repairs or improvements to premises.

8. LIENS. Lessee shall not permit any mechanic's, materialmen's or other similar liens to stand against the property for work and material furnished to Lessee, provided that Lessee shall have the right to contest the validity of any lien or claim; and further provided that if any such claim or lien is filed for record in the public records of Gadsden County, Florida such claim or lien shall be satisfied or transferred to the security furnished by Lessee with in thirty (30) days of service of such claim or lien upon the parties hereto. Failure to remove any claim or lien against said property shall constitute a default hereunder.

9. CONDEMNATION. In the event of a taking by eminent domain, all or any portion of the leased property, the proceeds from the land and building shall be and remain the sole property of the Lessor as between the Lessor and Lessee.

10. UTILITIES. Lessee shall be responsible for procuring and payment of all charges for electricity, sewer, water, light, heat, power and gas to the premises demised herein and shall indemnify Lessor against any liability or damages on such account.

11. BANKRUPTCY. It is agreed between the parties hereto that if Lessee shall be adjudicated a bankrupt or insolvent, or take the benefit of any Federal reorganization or composition proceeding, or make a general assignment, or take the benefit of any insolvency law; or if Lessee's leasehold interest under this lease shall be sold under any execution or process of law; or if a trustee in bankruptcy or a receiver be appointed or elected or had for Lessee (whether under Federal or state laws); or if said premises shall be abandoned or deserted; or if Lessee shall fail to perform any of the covenants or conditions of this lease on Lessee's part to be performed; or if this lease or the terms hereof be transferred or pass to or devolve upon any persons, firm, officer or corporation other than Lessee, by operation of law, or otherwise; then and in any such event this lease, at Lessor's option, shall expire and end five (5) days after Lessor has given Lessee written notice (in the manner provided) of such act, condition, or default, and Lessee hereby agrees immediately then to quit and surrender said premises to Lessor. If the term of this lease shall be so terminated, Lessor may immediately or at any time thereafter re-enter or repossess the premises and remove all persons and property there from without being liable for trespass or damages.

12. DEFAULT. In the event Lessee shall fail to timely pay any installment of rent due hereunder, or otherwise breaches any term, covenant or condition of this lease and if said breach or default is not cured within ten (10) days after written notice thereof, then in such event Lessor may at their option:

a. Institute an action or actions to enforce the performance of this lease:

b. Terminate this lease by notice to Lessee, re-enter the leased premises and recover damages, including but not limited to cost of repossession, reletting, attorney's fees and brokerage commission for services performed by the Lessor or by others. It is further agreed that upon termination of this lease by Lessor, Lessor shall have the right to remove any and all of the personal property located on the above-described premises without liability to Lessee for damage to said property or to the business of Lessee;

c. Demand acceleration of rental for the remaining term;

d. Exercise any other remedy allowed by law or equity.

14. LESSEE'S COMPLIANCE WITH ENVIRONMENTAL LAWS.

Lessee shall not use, or permit the premises to be used; in a manner that violates any applicable federal, state, or local law, regulation, or ordinance now or hereafter in force. This includes, but is not limited to, any law, regulation, or ordinance pertaining to air or water quality or emissions, the handling, transportation, storage, treatment, usage, or disposal of toxic or hazardous substances; or any other environmental matters. Compliance shall be at the sole cost and expense of Lessee, its agents, employees, contractors, or invitees.

Lessee shall immediately notify the Lessor of any spills, releases, or other potential failures to comply with applicable environmental laws and regulations, and of any inspections, notices, orders, fines or communications originating from environmental regulatory agencies.

Lessor, its officers, employees, contractors, or agents shall have the right, but not the duty, to inspect the premises, including the Lessee's records pertaining to environmental compliance, and conduct any sampling or tests necessary to verify Lessee's compliance with applicable environmental law or regulation, or if environmental contamination is detected, Lessee shall be responsible for all costs associated with such contamination or noncompliance.

15. LESSEE'S INDEMNIFICATION. Lessee agrees to indemnify, defend, and hold Lessor and its officers, employees, contractors, and agents harmless from all costs or liabilities arising from any environmental contamination or noncompliance with any applicable federal, state, or local environmental law, regulation, or ordinance now or hereafter in force, resulting from the operations of the Lessee, its agents, employees, contractors, or invitees.

This indemnification includes, without limitations, all claims, judgments, damages (including natural resource damages), penalties fines, and costs incurred in connection with any site investigation to determine the presence or extent of any contamination, as well as the costs of any cleanup, removal, or remedial work, whether or not it is required by any regulatory agency. Such costs shall include reasonable environmental consultant's and attorney's fees.

This indemnification clause shall survive the expiration or earlier termination of this lease.

16. DAMAGE OR THEFT OF PERSONAL PROPERTY. Lessee agrees that all personal property and fixtures brought into the Leased Premises shall be at the risk of the Lessee only and that the Lessor shall not be liable for theft or for any damages occasioned by acts of co-Lessees, or other occupants of the Premises or any other person, except for employees and agents of Lessor acting within the scope of their employment.

17. NOTICES. All notices required to be given shall be held to be properly given when delivered to the following named persons at the address shown, to wit:

Lessee: Midway Unity Fellowship, Inc. P. O. Box 515 Midway, FL 32343	Lessor: Gadsden County School Board Director of Facilities 805 South Stewart St. Quincy, FL 32351
--	--

The person to whom such notice may be given as above described may be changed from time to time by delivery of written notice thereof to the opposite party. Such changes shall be given in writing to the opposite party designating the person to whom such notices are to be directed.

18. ATTORNEY'S FEE. If any rent owing under this Lease is collected by or through an Attorney at Law, Lessee agrees to pay Lessor's reasonable attorney's fees and court costs. If the Lessor or the Lessee defaults in the performance of any of the covenants of this Lease and by reason thereof the Lessor or the Lessee employs the services of an attorney to enforce performance of said covenants, the non-prevailing party shall pay the reasonable attorney's fees and expenses and costs incurred by the prevailing party in the enforcement of any remedy available to it.

19. HOLDING OVER. In the event of holding over by Lessee subsequent to the expiration or other termination of this Lease and without regard to Lessor's acquiescence or consent, Lessee shall pay as liquidated damages a monthly rent equal to 200% of the monthly rent payable immediately prior to such expiration or termination of this Lease for the duration of such holdover period. Additionally, during such holding over with Lessor's acquiescence and without any express agreement of the parties, the Lessee shall be a tenant on a month-to-month basis which tenancy shall be terminated absolutely and without remedy upon thirty (30) days prior written notice of such intent by either party. There shall be no renewal of this Lease by operation of law.

20. QUIET ENJOYMENT. If Lessee observes and performs all covenants, terms and conditions hereof, Lessee shall peaceably and quietly hold and enjoy the leased premises for the lease term without interruption by Lessor or any person or persons to whom such notices are to be directed.

21. SIGNS. Lessee shall not place, construct, erect, affix or attach any sign, billboard or other advertising material on the premises or portable brought onto the premises without the prior written consent of Lessor as to the location, size, material to be used, design, and substance of advertising material to be contained on the sign. Lessor may withhold its consent for purely aesthetic reasons and if it determines in its sole discretion that said advertising media and/or proposed sign is not in keeping with Lessor's policies. All costs associated with the purchase and installation of approved be borne by Lessee.

22. TAXES. Lessor shall be responsible for all ad valorem taxes on the leased premises; however, Lessee shall be responsible for all taxes on his personal property.

23. TIME OF ESSENCE. Time is of the essence of this agreement.

24. WAIVER. The failure of either party to insist on strict performance of any covenant or condition hereof shall not be construed a waiver of such covenant or condition in any other instance. This lease cannot be changed or terminated orally.

25. MAINTENANCE. Lessee shall be responsible for its prorate share of landscape and maintenance costs for future landscaping of the property at Mine Road, based on the Lessee's square footage compared to the total leasable square footage of the building at that location.

26. ENTIRE AGREEMENT. This lease contains the entire agreement of the parties and no representations, inducements, promises or agreements, oral or otherwise, between the parties not embodied herein shall be of any force or effect. No failure of the Lessor to exercise any power given the Lessor hereunder, or to insist upon strict compliance by the Lessee of any obligation hereunder, and no custom or practice of the parties at variance with the terms hereof shall constitute a waiver of the Lessor's right to demand exact compliance with the terms hereof.

IN WITNESS WHEREOF, the Lessee has caused these presents to be signed in its name by its duly authorized officer and its corporate seal to be affixed the day and year first above written, and the Lessors have hereunto set their hands and seals the year first above written.

LESSOR:

SCHOOL BOARD OF GADSDEN
COUNTY, FLORIDA

By: Isaac Simmons, Jr.

(Print Name: ISAAC SIMMONS, JR.)

As its: Chairman

LESSEE:

MIDWAY UNITY FELLOWSHIP, INC.

By: Douglas M. Harris

(Print Name: Douglas M. Harris)

As its: PRESIDENT

Thomas P. Skipper
Professional Surveyor and Mapper
16 East Washington Street
Quincy, Florida 32351
(850) 627-9754

October 20, 2009
Legal Description for School Board of Gadsden County
5.00 Acres Out of 25.00 Acre Tract
Located on Mine Road, Midway, Florida

A parcel of land lying in the Southwest one quarter of Section 8, Township 1 North, Range 2 West, Midway, Gadsden County, Florida, being more particularly described by metes and bounds as follows:
Commence at a found iron pipe (2 inch, filled with concrete) known as marking the Southeast corner of said Southwest one quarter and run;

Thence North 00 degrees 13 minutes 07 seconds East along the Eastern boundary of said Southwest one quarter a distance of 393.79 feet;

Thence North 89 degrees 46 minutes 53 seconds West 13.59 feet to a concrete monument (PSM3031) on the Westerly maintained right of way boundary of a county paved roadway known as Mine Road for the POINT OF BEGINNING.

From said POINT OF BEGINNING thence North 01 degree 35 minutes 56 seconds East along said Westerly maintained right of way boundary a distance of 260.00 feet to a concrete monument (PSM3031);

Thence North 89 degrees 51 minutes 17 seconds West 837.96 feet to a concrete monument (PSM3031);

Thence South 01 degree 35 minutes 56 seconds West 260.00 feet to a concrete monument (PSM3031);

Thence South 89 degrees 51 minutes 17 seconds East 837.96 feet to the POINT OF BEGINNING.

Containing 5.00 acres, more or less.

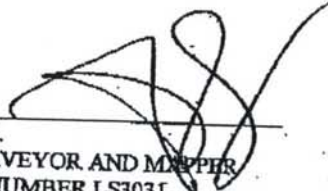
THOMAS P. SKIPPER
PROFESSIONAL SURVEYOR AND MAPPER
FLORIDA LICENSE NUMBER LS3031



PROJECT PROPOSAL

For the

CHATAHOOCHEE HIGH SCHOOL

613 Chattahoochee St Chattahoochee, FL. 32324-0007

To the

School Board of Gadsden County, Florida

Submitted by:

Faith Apostolic Christian
Tabernacle Service (FACTS)

Bishop Terry Fitzgerald (Pastor)

Trustees:

**Cedric Conyers
Dexter Kenon
Martha Kenon
Mary Smith
Abe Johnson**



**FAITH APOSTOLIC CHRISTIAN
TABERNACLE SERVICES, INC.**



**Pastors:
Bishop Terry & Brenda Fitzgerald**

Faith Apostolic Christian Tabernacle Service (FACTS), a Florida Non- Profit Corporation, a full gospel Word-based church, is considered to be a hospital for the broken hearted, the down trodden, and the poor in spirit, etc. FACTS is a warm, friendly, and dynamic place to come, grow, and worship our Saviour and Lord Jesus Christ, - in Faith, Spirit, and Truth. The FACTS mission is to offer programs that will develop the whole person.

Faith Apostolic Christian Tabernacle Service (FACTS)

Attn. Bishop Terry Fitzgerald
2540 Florida/Georgia Highway
Havana, FL. 32333
Telephone: (850) 539-3032

Bishop Terry Fitzgerald

160 Fulton Shaw Road
Quincy, FL. 32352
Telephone Numbers: (850) 875-4994
Email Address: bishopterryfitzgerald@ yahoo.com

VISION STATEMENT:

From Memory to Mission

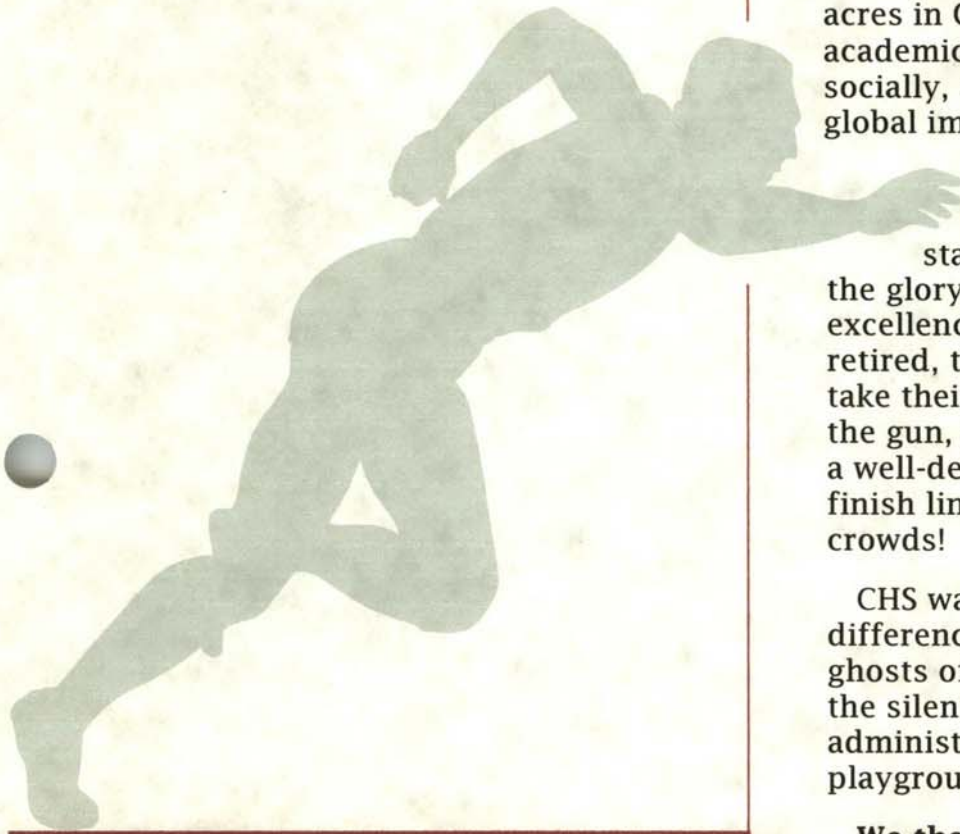

From site planning, laying of the first brick, to administration staffing, Chattahoochee High School was built to change lives.

The work force of CHS, its administration, teachers, coaches, custodians, parents of its student body, and the community at-large, had one united focus - CHANGE! The seed of change that was sowed on 33 acres in Gadsden County has been felt academically, medically, militarily, socially, and scientifically - making a global impact.

Now Retired, CHS is like the legendary "track star," Jessie Owens, who lived the glory, and set the bar of excellence high. Now physically retired, their spirits live - waiting to take their stand, to hear the sound of the gun, and off with fluid strides on a well-defined course towards the finish line with the roar of the crowds!

CHS was built to make a difference and to change lives. The ghosts of yesteryears have risen from the silent hallways, classrooms, administrative offices, cafeteria, and playgrounds.

We the FACTS Ministry wish to give extended life to a legacy.

By using, the same course (33 acres), and the facilities once used by CHS, we wish to impact change in the lives of others through the following programs...

Faith Apostolic Christian
Tabernacle Service
(FACTS)



PROGRAM DISCRIPTION

■ **Bridges To Growth**

The Bridge to Growth Program proposes a weekend and holidays free library that circulates children's toys, games, puzzles, music, books, and other materials that are not only fun, but also aid children in their learning and development.

■ **Youth with a Purpose (YWAP)**

"Youth with a Purpose" (YWAP) is a signature pilot program of FACTS, designed to awaken youth to God's design for their lives. It deals with issuers of forgiveness, self-pity, rejection, ill-dependencies, and fosters hope in overcoming the obstacles of realities. YWAP focus is developing the capacities of the trainee to see his /her failures as "overcomeable."

■ **Effective Parenting**

FACTS' proposes effective parent training to parents using Kids Health materials such as, Nine Steps to More Effective Parenting. The program is based on various ways to handle child-rearing responsibilities and help parents feel more fulfilled as a parent and enjoy their child more.

■ **Gulf Coast College School of Ministry**

FACTS' affiliation with Gulf College & Seminary allows its members and the community at large, an accredited program of study at the undergraduate college level.

■ **Culinary Arts Lab**

The proposed training program will cultivate and continue a tradition of hospitality, service, and food creation that has been tendered with over 40 years of work and creativity.

■ **Project Concern**

Is a Reporting Center designed to bridge the gap between the school, parent/ home, and the courts. More than a suspension baby-sitter, the FACTS Center is dedicated to befriending and helping children find balance during the time of suspension and jump-starting each child towards a positive future.

■ **The Church**

Faith Apostolic Christian Tabernacle Service (FACTS) is a hospital for the broken hearted, the down trodden and the poor in spirit, etc. FACTS is a warm, friendly, and dynamic place to come and worship our Saviour, and Lord Christ Jesus, in Faith, Spirit and Truth. We are a full gospel church that is Word based offering programs to the whole person.



PROJECT PROPOSAL

1. Funding Required

A. Seeking Private Mortgage Financing from Seller of the **Chattahoochee High School** at 613 Chattahoochee St., Chattahoochee, FL 32324. Proposed Seller Private Mortgage at \$1,612.16 monthly for twenty-five years with interest of 1.00% . Total equal approximately \$350,550.00. Buyer reserves the right to make a cash payoff offer contingent upon a commercial land appraisal and approved bank financing on or before the end of term.

B. Property Coverage Considerations

If your church were to catch fire, what would it cost to replace everything in side? What about the stuff you can't even remember? To keep account of what's in the church, make a detailed inventory of everything, videotaping if possible.

Next, consider whether you want coverage for the existing value of the items, which includes depreciation, or their re placement value, which is what it will cost to buy them new. Factor in extra coverage for antique items, high-value furnishings, or important papers and records.

1. *Special form including theft.* Powell recommends this be added to the church's property coverage. "Churches with this policy have more protection than those with a fire and extended coverage policy, which only covers the church in case of fire or a handful of named perils, such as lightning and wind," he says.
2. *Ordinance and law coverage.* Rebuilding after a disaster may be more costly than you expect. You may have to add wheelchair ramps and elevators, or meet other building codes that have been enacted since your church was built. This coverage covers some of that cost.
3. *Liability coverage.* Does your property insurance cover people who may be injured on your grounds? Timothy J. McCurdy of Christian Care Ministry tells about one church that could not put basketball hoops on its property because it didn't have enough insurance to cover a neighborhood child who might be injured during play. Imagine specific, unusual problems that might occur on your property, and make sure you have enough coverage for each.
4. *Systems breakdown coverage.* This is helpful in case your church's electrical system or HVAC system shuts down.

Annual Insurance Estimate: Comprehensive about \$1.5 million in property insured with an annual total premium is about \$8,000 per year.

Total Monthly Mortgage plus Insurance \$1,612.16 plus \$666.00 = \$2278.16



Gadsden County Parcel Maps

Gadsden Home | Map Help | Turn Quick Info On | Search Page

Zoom Out | Zoom In

Parby Hand | Zoom To Parcel

Zoom County | Center On Parcel

Measure | Area Tool

Print Page | Search Sales

Copyright © 2006, gpublic.net

Report Legend

PARCEL INFORMATION TABLE			
Selected Parcel	1-33-4N-6W-0000-00442-0000 (Click for Complete Card)		
DOR Property Usage	SCHOOLS, PUBLIC (83)		
Acres	33		
Property Use	PUBLIC SCH		
Land Use	SCHOOL		
OWNERSHIP INFORMATION			
Name	SCHOOL BOARD OF GADSDEN COUNTY		
Mailing Address	COUNTY FLA CHATTAHOOCHEE HIGH; 35 MARTIN LUTHER KING BLVD QUINCY, FL 32351		
Situs/Physical Address	613 CHATTAHOOCHEE ST		
VALUES			
Land Value	74,250		
Ag Land Value	0		
Building Value	0		
Misc Value	510,000		
Just Value	584,250		
Assessed Value	584,250		
Exempt Value	584,250		
Taxable Value	0		
Homestead?	N		
LAST 2 SALES			
Date	Price	Vacant?	Qual

Show:

- Parcels
- Roads
- Lakes & Rivers
- Elevation
- Railroads
- Yearly Sales
- Parcel Numbers
- Lots
- Dimensions
- Sec-Twn-Rng
- Future Land Use
- Aerial Photography

1:14,442

The Gadsden County Property Appraiser's Office makes every effort to produce the most accurate information possible. No warranties, expressed or implied, are provided for the data herein, its use or interpretation. The assessment information is from the last certified taxroll. All data is subject to change before the next certified taxroll. PLEASE NOTE THAT THE PROPERTY APPRAISER MAPS ARE FOR ASSESSMENT PURPOSES ONLY NEITHER GADSDEN COUNTY NOR ITS EMPLOYEES ASSUME RESPONSIBILITY FOR ERRORS OR OMISSIONS ---THIS IS NOT A SURVEY---

Gadsden Home Search Page
© Website design by gpublic.net



Gadsden County--Property Legal Description

Page 1 of 1

The seal of Gadsden County, Florida, featuring a central figure and the words 'GADSDEN COUNTY FLORIDA'.	<p>Gadsden County Property Appraiser's Office Clay VanLandingham, CFA COUNTY APPRAISER</p>	<p>16 S. CALHOUN ST QUINCY, FL 32353-0585 PH (950) 627-7169 FAX (950) 627-0399</p>
---	--	--

COMPLETE LEGAL DESCRIPTION FOR PARCEL 1-33-4N-6W-0000-00442-0000

DB 91, P. 104-DB 107, P. 4- COMM. AT SWC OF E1/2 OF SE1/4 RUN N. 0° 45' W. 365.4 FT. TO BEGIN, N. 0° 45' W. 78.1 FT., N. 87° 45' W. 297 FT., N. 11° 50' E. 377.5 FT N. 0° 45' W. 250 FT., N. 89° 15' E. 210 FT., N. 0° 45' W. 589 FT., N. 89° 15' E. 700 FT., S. 45° E. 365 FT., S. 70° 36' E. 660.4 FT., S. 0° 45' E. 590.5 FT., N. 70° 36' W. 660.4 FT., S. 0° 45' E. 353.5 FT., S. 89° 15' W. 700 FT. TO THE P.O.B. LESS PART TO S.R.D. PER OR 65 P 388 IN SECTION 33-4N-6W.

Contract for Deed

-Copy 1-

CONTRACT FOR DEED

THIS CONTRACT FOR DEED is made and entered into this 15 day of December, 2009, by and between SCHOOL BOARD OF GADSDEN COUNTY, (hereinafter referred to as "Seller"), and FAITH APOSTOLIC CHRISTIAN TABERNACLE SERVICES, INC., (hereinafter referred to as "Buyer"), collectively referred to Parties.

WITNESSETH, that if the Buyer shall first make the payments and perform the covenants hereinafter mentioned on his part to be made and performed, the Seller hereby covenants and agrees to convey to the Buyer, his heirs, executors, administrators, personal representatives, or assigns, in fee simple absolute, clear of all encumbrances by a good and sufficient warranty deed or equivalent deed, that Property ("Property") situated in the County of Gadsden, State of Florida, more fully described on Exhibit "A", attached hereto and made a part hereof.

The sale of the Property (and the term "Property") shall include all buildings and improvements on the property and all right, title and interest of Seller in and to adjacent streets, roads, alleys and rights-of-way. The sale of the Property shall also include the following fixtures and personal property associated with the Property (unless specifically excluded below), all of which (if any) are owned by Seller free and clear of all liens and encumbrances, including: gas heaters; propane tanks (including propane if owned); central heating, ventilation and air conditioning equipment and fixtures; sump pumps; attached TV antennas and cables; lighting and light fixtures; plumbing equipment and fixtures; attached mirrors; linoleum; wall-to-wall carpet; window and porch shades; blinds; storm windows and doors; screens; curtain and drapery rods; awnings; automated garage door openers and remote control units; keys; attached humidifiers; attached outside cooking units; attached fireplace screens and/or glass doors; attic and ceiling fans; built-in kitchen appliances; and table, chairs, equipment, etc:

All property attached or unattached both inside and outside including utility poles, etc., that's not specifically excluded below.

(Included Items).

The following items are specifically excluded from this contract and shall not be transferred to Buyer as a part of the Property:

(Excluded Items)

<i>Initials</i>	
Seller	_____
Buyer	<u>TF</u>

PRICE AND PAYMENT

Buyer herein covenants and agrees to pay to the Seller the sum of Three Hundred and Fifty Thousand and Five-hundred and Fifty Dollars (\$350,550.00) as the purchase price for the Property, as follows

[T.F. / _____] The principal sum of Three Hundred and Fifty Thousand and Five hundred and Fifty Dollars (\$ 350,550.00) with interest on the whole sum at the rate of one percent (1.00%) percent per annum, payable in monthly installments of One Thousand and Six-hundred and twelve Dollars and sixteen cents (\$1,612.16 beginning on the 1st day of February, 2010, and continuing on the 1st day of each and every month thereafter, until the 1st day of February, 2015, when all remaining principal of \$269,369.10 is due. The total Principle and Interest paid is Three Hundred and Eighty-one Thousand and Six hundred and Forty-seven Dollars and eighty cents (\$ 381,647.80).

Any interest that may be charged, shall be computed monthly and deducted from the payment and the balance of the payment shall be applied to the principal

SECURITY

This Contract shall stand as security for the performance of Buyer and as security of the payment of the obligation of Buyer under this Contract. All improvements on the Property, including, but not limited to, buildings, fixtures, trees or other improvements now on the Property, or hereafter made or placed thereon, shall also be part of the security for the performance of this contract and shall not be removed from the Property.

AS-IS CONDITION OF PROPERTY

Buyer accepts the Property "as-is" without any type of warranty thereon. Buyer further understands that Seller has not made and does not make any representations or warranties of any kind as to the condition of the Property, buildings, improvements or fixtures located thereon, and/or the location of the boundaries of the Property.

DEED AND EVIDENCE OF TITLE

Upon payment of the total purchase price and other amounts, including any late charge, by Buyer, Seller will, at Seller's expense, deliver a Statutory or General Warranty Deed to the Property to Buyer, free and clear of any liens or encumbrances other than taxes and assessments for the current year.

	<i>Initials</i>
Seller	_____
Buyer	<u>T.F.</u> _____

TITLE

Title shall be conveyed free and clear of all encumbrances except those mortgages or liens, if any, mentioned herein, easements, restrictions, limitations, reservations, covenants and conditions of record not coupled with a possibility of reverter, right of reentry or other reverter right which amounts to a qualification of the fee, and subject also to applicable zoning ordinances and real estate taxes for the year in which the deed is delivered, and thereafter.

TAXES AND ASSESSMENTS

The Buyer agrees to pay all taxes, assessments, or impositions that may be legally levied or imposed upon said land apportioned as of the date of this Contract.

RISK OF LOSS AND INSURANCE

Risk of loss by negligence, fire or other casualty is on the Buyer. The Buyer agrees to keep the Property insured, by at least content, liability, fire, casualty, hazard, and windstorm, insurance, with an insurance company satisfactory to the Seller for a sum not less than its full insurable value. All insurance proceeds shall be payable to the Seller. In the event of a loss by fire or other casualty, the rights and obligations of the parties shall be as follows:

a. If the damage to the Property and/ or building(s) is less than fifty (50%) percent of the total value of the improvements, the Buyer shall be obligated to repair or reconstruct, as the case may be, and the Seller shall either turn over the insurance proceeds to the Buyer or apply the proceeds directly to the costs of such repair or reconstruction, the Buyer being entitled to any surplus insurance funds over and above the costs of repair or reconstruction, and the Buyer being liable for any deficiency after application of the insurance money to such costs.

b. If the damage to the Property and/ or building(s) is in excess of fifty (50%) percent of the total value of the improvements, the Buyer shall have the option as to whether to repair or reconstruct following such casualty loss.

	<i>Initials</i>
Seller	_____
Buyer	<i>TR</i> _____

(1) If the Buyer elects not to repair or reconstruct, then the unpaid balance of the purchase price, together with accrued interest to date, but excluding unearned interest, shall at the option of the Seller become due and payable forthwith, and the insurance proceeds shall be applied towards the application of such sum, any surplus of the insurance proceeds over and above the Buyer's obligations shall be paid to the Buyer. In the event that the contract is paid out as a result of the application of the insurance proceeds, the Seller shall deliver a deed to the Buyer and consummate the transaction. In the event the contract is not paid out as a result of the application of the insurance process pursuant to an election not to repair or reconstruct after casualty, the proceeds shall be credited to the account of the Buyer and the Buyer will continue to make regular payments pursuant to the terms of the contract until the Buyer's obligations are satisfied and the contract consummated.

(2) If the Buyer elects to repair or reconstruct, the insurance proceeds shall be applied by the Seller to the costs of such repair or reconstruction, the Buyer shall submit the building plans to the Seller for approval, which approval shall be granted if the value of the land after the repair or reconstruction will equal or exceed the value of the land immediately prior to the casualty. If requested by the Buyer, the Seller will, after approval of the Buyer's building plans, turn over the insurance proceeds to an insurance trustee for the purpose of paying for the repairs or reconstruction. Any surplus of insurance proceeds over and above the costs of repair or reconstruction shall be delivered to the Buyer, and any deficiency remaining after application of such proceeds to the costs of repair or reconstruction shall be paid by the Buyer.

EMINENT DOMAIN

In the event that any or all of the property is taken by eminent domain during the existence of this Contract, the rights and obligations shall be as follows:

- a. If the amount taken is less than fifty (50%) percent of the total value of the property at the time of the taking, the entire award shall be paid to the Buyer and the contract shall continue unaffected by the taking.

- b. If the amount taken is more than fifty (50%) percent of the total value of the property but less than seventy-five (75%) percent of the total value at the time of the taking,

	<i>Initials</i>
Seller	_____
Buyer	<i>TF</i> _____

(1) if the value of the property remaining is equal to twice the amount of the Buyer's indebtedness under the contract, then the entire award shall be paid to the Buyer and the contract shall continue unaffected by the taking, but,

(2) if the value of the property remaining is less than twice the amount of the Buyer's indebtedness under the contract, then so much of the award shall be paid to the Seller as to reduce the outstanding indebtedness of the Buyer under the contract to a point where the value of the property not taken is equal to twice the remaining outstanding indebtedness under the contract, the balance of the award shall be paid to the Buyer, and the contract as thus accelerated as to the final payment shall continue unaffected by the taking.

However, such sums as are necessary for the useful alteration or restoration of the uncondemned portion of the property shall be applied for such purpose before the remaining portion of the award is turned over to the Seller for reduction of the debt. In determining the value of the uncondemned portion of the property, the value shall be the fair market value after the completion of such repairs or alterations as may have been necessitated by the condemnation.

c. If the amount taken is more than seventy-five (75%) percent of the total value of the property at the time of the taking, then the award shall be paid to the Seller to the extent that is necessary to pay out the contract, such sum including accrued interest to date, but excluding unearned interest, and the balance of the award shall be paid to the Buyer. The contract will thus be consummated and the Seller will convey to the Buyer any of the property herein included which was not taken by eminent domain. In the event the amount of the award is insufficient to satisfy the outstanding obligations of the Buyer to the Seller, excluding unearned interest, the contract shall nevertheless be terminated as previously provided in this paragraph, but the Seller shall be authorized to sue for a money judgment for any deficiency between the amount of the award and the outstanding obligations of the Buyer.

d. The provisions of this Paragraph shall apply also to any settlement or agreement reached between the Buyer and any corporation, authority or agency having the power of eminent domain whereby the Buyer voluntarily conveys to such agency, authority, or corporation in order to avoid condemnation proceedings.

<i>Initials</i>	
Seller	_____
Buyer	<u>T.Y.</u>

PREPAYMENT

The Buyer may prepay the entire balance outstanding at any time without penalty and without notice. Such prepayment shall not include unearned interest. Upon full prepayment, the Seller shall have twenty (20) days in which to deliver a warranty deed or equivalent deed.

POSSESSION OF PROPERTY

Upon execution of this Contract Buyer shall take possession of the Property and shall enjoy peaceful possession of the Property for as long as all payments due under this agreement are made in a timely manner and all other terms and covenants are complied with.

TIME OF THE ESSENCE

Time is of the essence with respect to the terms and provisions of this Contract. The time of each payment shall also be an essential part of this contract.

DEFAULT BY SELLER

In case of the failure of the Seller to comply with the terms of this Contract or to perform any of the covenants hereby made and entered into, the Buyer shall have the option to collect damages at law or to demand specific performance, costs and reasonable attorney's fees from the Seller.

DEFAULT BY BUYER

If Buyer fails to make any payment due under this Contract or fails to perform any covenant, term or condition required by this Contract on or before the due date, Seller shall give Buyer a notice of default or performance ("Notice"). The Notice shall state that Buyer is allowed fourteen (14) days from the date of the Notice to cure the default or performance. If the default or failure of performance is not cured within the 14 day time period, then Seller shall have, at Seller's option, any of the following remedies:

- (a) Give Buyer a written notice specifying the failure to cure the default or performance ("Notice of Failure to Cure") and informing the Buyer that if the default continues for an additional fifteen (15) days after service of the "Notice of Failure to Cure" that without further notice, this Contract shall be cancelled and terminated and Seller may regain possession of the Property as provided herein. Buyer shall forfeit all payments made by him to date on this agreement (including taxes and assessments) and said amount (paid to Seller) shall be retained by the Seller in full satisfaction and liquidation of all damages sustained by the Seller. Seller shall have the right to reenter and to take immediate possession of the Property without being liable in any action in trespass, or otherwise, and to seek such self-help remedies or other remedies as shall place the Seller in exclusive possession of the premises.

<i>Initials</i>	
Seller	_____
Buyer	<i>JR</i> _____

Buyer expressly agrees that in the event of default which is not cured by Buyer and termination of this Contract, and if Buyer fails to vacate the Property, Seller shall have the right to obtain possession by appropriate court action. Seller shall also be entitled to recover such other damages as they may be due which are caused by the acts or negligence of Buyer.

(b) Give the Buyer a written notice specifying the failure to cure the default or performance ("Notice of Failure to Cure") and informing the Buyer that if the default continues for an additional fifteen (15) days after service of the "Notice of Failure to Cure" that without further notice, the entire principal balance and any unpaid interest shall be due and payable immediately, and Seller may take any appropriate action against Buyer for collection of the entire principal balance and any unpaid interest according to the laws of the State of

Florida All costs and expenses of collection, by foreclosure, or otherwise, including reasonable attorney's fees, shall be paid by the Buyer, and all such sums are hereby secured by this agreement.

MAINTENANCE OF PROPERTY

The Buyer will not permit, commit or suffer waste and will maintain the Property at all times in a state of good repair and condition, and will not do or permit to be done anything to the Property that will in any way impair or weaken the security of the Seller's title. In case of the refusal, neglect or inability of the Buyer to repair and maintain said Property, the Seller may, at the Seller's option, make such repairs or cause the same to be made, and advance money in that behalf, which sums advanced or costs of repairs shall be the obligation of the Buyer and shall be secured by this Contract.

RETURN OF PROPERTY

In the event this Contract is terminated and Buyer is required to return the Property to Seller as may be required by the terms of this Contract, Buyer agrees to return the property to Seller in substantially the same condition, as it now exists, ordinary wear and tear excepted. Seller reserves the right to inspect the property at any time by giving Buyer reasonable notice.

RECORDING

While this Contract may be recorded, the Seller may record a Notice of Termination of said Contract if the Buyer defaults in the performance of the Buyer's obligations and responsibilities under this Contract under the laws of the State of Florida.

<i>Initials</i>	
Seller	_____
Buyer	<u>J.F.</u>

MORTGAGE BY SELLER

During the lifetime of this Contract, Seller may place a mortgage on the Property, which shall become a lien on the Property, superior to the rights of the Buyer, or may continue and renew any existing mortgage on the Property, as long as the total amount due on all outstanding mortgages is not, at any time, greater than the unpaid balance under this Contract.

If Seller's interest in the Property is at any time encumbered by a mortgage, Seller agrees to perform all obligations under the mortgage and to make all payments of principal and interest on the mortgage as they become due. Seller further agrees to produce evidence of any such payments to Buyer upon Buyer's demand. If Seller defaults on any such mortgage or land contract, Buyer shall have the right to make any necessary payments or take any necessary actions to cure the default and Buyer will be reimbursed by receiving credit to this Contract to apply to any payments that are due or will become due.

CONVEYANCE BY SELLER

The Seller reserves the right to convey, Seller's interest in the Property. Such conveyance shall not be a cause for rescission of this Contract and shall be subject to the terms of this Contract

JOINT AND SEVERAL LIABILITY

If there is more than one Buyer, then all Buyers covenant and agree to joint and several liability and obligations with respect to this Contract.

REINSTATEMENT AFTER ACCELERATION

If Buyer defaults under the terms of this Contract and payments are accelerated hereunder, Buyer shall have the right to reinstate this Contract as allowed by the laws of the State of Florida, provided that Buyer:

- (a) pays Seller all sums due at that time under this Contract as if no acceleration had occurred;
- (b) cures any default or other covenant or agreement; and
- (c) reimburses all expenses incurred by Seller in enforcing this Contract and protecting Seller's interest in the property, including, but not limited to, reasonable attorneys' fees.
- (d) pay any reinstatement amounts and expenses by: cash, valid money order, valid certified check, valid bank check, or valid cashier's check

In the event of any reinstatement, this Security Instrument and any obligations secured hereby shall remain fully effective as if no acceleration had ever occurred.

<i>Initials</i>	
Seller	_____
Buyer	<u> <i>JF</i> </u>

NOTICES

Any notice to be given or to be served upon any party hereto, in connection with this Contract, must be in writing. A notice may be delivered to a party at the address that follows a party's signature or to a new address that a party designates in writing. A notice may be delivered: (1) in person; (2) by certified mail; or (3) by overnight courier as follows: If to Seller:

SELLER SCHOOL BOARD OF
GADSDEN COUNTY 35 MARTIN
ADDRESS: LUTHER KING JR BLVD
CITY QUINCY
STATE AND ZIP FL 32351-4400

Seller _____
Address: _____
City _____
State and Zip _____

and if to Buyer:

BUYER FAITH APOSTOLIC CHRISTIAN
TABERNACLE SERVICES, INC.
ADDRESS: 160 FULTON SHAW RD
CITY QUINCY
STATE AND ZIP FL 32352-0381

Buyer _____
Address: _____
City _____
State and Zip _____

ASSIGNMENT OR SALE BY BUYER

Buyer shall not sell, assign, transfer or convey any interest in the Property or this Agreement, without the prior written consent by Seller. In the event Seller gives Buyer permission to transfer or convey Buyer's interest, such conveyance shall not be a cause for rescission of this Contract and shall be subject to the terms of this Contract.

PARTIES

If Seller or Buyer constitutes two or more persons, the terms "Seller" or "Buyer" shall be construed to read "Sellers" or "Buyers" whenever the sense of the Contract requires. Unless identified as Seller or Buyer, no real estate professional, escrow agent or closing agent is a party to this Contract.

	<i>Initials</i>
Seller	_____
Buyer	<u>T.F.</u>

SINGULAR, PLURAL AND GENDER

The words "Seller" and "Buyer" herein employed shall be construed to include the plural as well as the singular, and the masculine shall include the feminine and neuter where the context so admits or requires.

PENDING LITIGATION

Seller warrants and represents that there are no legal actions, suits or other legal or administrative proceedings, including cases, pending or threatened or similar proceedings affecting the Property or any portion thereof, nor has Seller knowledge that any such action is presently contemplated which might or does affect the conveyance contemplated hereunder.

GOVERNING LAW

This Contract and all transactions contemplated hereby, shall be governed by, construed and enforced in accordance with the laws of the State of Florida.

DISPUTES

(select appropriate provisions)

- Litigation.** If a dispute arises, either party may take the matter to court.
- Mediation and Possible Litigation.** If a dispute arises, the parties will try in good faith to settle it through mediation conducted by
 - _____.
 - a mediator to be mutually selected.
 The parties will share the costs of the mediator equally. Each party will cooperate fully and fairly with the mediator and will attempt to reach a mutually satisfactory compromise to the dispute. If the dispute is not resolved within 30 days after it is referred to the mediator, either party may take the matter to court.

- Mediation and Possible Arbitration.** If a dispute arises, the parties will try in good faith to settle it through mediation conducted by
 - _____.
 - a mediator to be mutually selected.
 The parties will share the costs of the mediator equally. Each party will cooperate fully and fairly with the mediator and will attempt to reach a mutually satisfactory compromise to the dispute. If the dispute is not resolved within 30 days after it is referred to the mediator, it will be arbitrated by
 - _____.
 - an arbitrator to be mutually selected.

<i>Initials</i>	
Seller	_____
Buyer	<u>T.F.</u>

Judgment on the arbitration award may be entered in any court that has jurisdiction over the matter. Costs of arbitration, including lawyers' fees, will be allocated by the arbitrator.

ATTORNEY FEES AND COSTS

In connection with any litigation including appellate proceedings arising out of this Agreement, the prevailing party shall be entitled to recover reasonable attorney's fees and court costs, and all other expenses, whether or not taxable by the court as costs, in addition to any other relief to which the prevailing party may be entitled.

SEVERABILITY

If any court determines that any provision of this contract is invalid or unenforceable, any invalidity or unenforceability will affect only that provision and will not make any other provision of this contract invalid or unenforceable and such provision shall be modified, amended or limited only to the extent necessary to render it valid and enforceable.

WAIVER

If one party waives any term or provision of this contract at any time, that waiver will only be effective for the specific instance and specific purpose for which the waiver was given. If either party fails to exercise or delays exercising any of its rights or remedies under this contract, that party retains the right to enforce that term or provision at a later time.

BINDING EFFECT

This Agreement and covenants herein shall be binding upon and shall inure to the benefit of the parties hereto and their successors, heirs, executors, administrators, personal representatives and assigns. However, nothing shall authorize a transfer in violation of any other provisions in the Agreement.

COUNTERPARTS

This Contract may be executed in several counterparts, each constituting a duplicate original, but all such counterparts constituting one and the same Agreement.

INTERPRETATION

Whenever the context hereof shall require, the singular shall include the plural, the male gender shall include the female gender and the neuter, and vice versa.

<i>Initials</i>	
Seller	_____
Buyer	<i>TF</i> _____

TYPEWRITTEN OR HANDWRITTEN PROVISIONS

Typewritten or handwritten provisions inserted herein or attached hereto as Addenda shall control all printed provisions in conflict therewith.

ENTIRE AGREEMENT

This Contract is the entire agreement between the parties with respect to the transaction contemplated herein. It replaces and supersedes any and all oral agreements between the parties, as well as any prior writings. Neither this Contract nor any provision hereof may be waived, modified, amended, discharged, or terminated except by an instrument in writing signed by the party against which the enforcement of such waiver, modification, amendment, discharge or termination is sought, and then only to the extent set forth in such instrument.

ADDITIONAL AGREEMENTS

Seller and Buyer additionally agree that: A copy of the request to transfer the leasehold agreement for property described as athletics' fields adjacent to and for non-profit purposes as original intended by the leasehold agreement wherein that Property ("Property") situated in the County of Gadsden , State of Florida, more fully described on Exhibit "B", attached hereto and made a part hereof.

<i>Initials</i>	
Seller	_____
Buyer	<u>TR</u>

THIS IS INTENDED TO BE A LEGALLY BINDING CONTRACT. CONSULT AN ATTORNEY AND A TAX PROFESSIONAL BEFORE SIGNING IT, TO MAKE SURE YOU UNDERSTAND ALL OF THE TERMS AND LEGAL AND TAX CONSEQUENCES.

IN WITNESS WHEREOF, the Parties have hereunto set their hands and seals the day and year first above written.

SIGNATURE

-FOR-
SELLER SCHOOL BOARD OF
GADSDEN COUNTY 35 MARTIN
ADDRESS: LUTHER KING JR BLVD
CITY QUINCY
STATE AND ZIP FL 32351-4400

SIGNATURE

-FOR-
SELLER SCHOOL BOARD OF
GADSDEN COUNTY 35 MARTIN
ADDRESS: LUTHER KING JR BLVD
CITY QUINCY
STATE AND ZIP FL 32351-4400

SIGNATURE



-FOR-
BUYER FAITH APOSTOLIC
CHRISTIAN TABERNACLE
SERVICES, INC.
ADDRESS: 160 FULTON SHAW RD
CITY QUINCY
STATE AND ZIP FL 32352-0381

SIGNATURE



-FOR-
BUYER FAITH APOSTOLIC
CHRISTIAN TABERNACLE
SERVICES, INC.
ADDRESS: 160 FULTON SHAW RD
CITY QUINCY
STATE AND ZIP FL 32352-0381

<i>Initials</i>	
Seller	_____
Buyer	<u>IF</u>

State of Florida)
County of Gadsden) ss

Before me personally appeared Abe Johnson ✓ Terry Fitzgerald to me well known and known to me to be the person(s) described in and who executed the foregoing instrument, and acknowledged to and before me that they executed said instrument for the purposes therein expressed.

WITNESS my hand and official seal, this 22nd day of Dec., 2009

Diane S Mckeown
Signature of person taking acknowledgment (Notary Public)



DIANE S. MCKEOWN
Commission DD 643484
Expires March 6, 2011
Bonded Thru Troy Fain Insurance 900-385-7019

(SEAL)

Name typed, printed, or stamped

6 March 11
My Commission Expires

Initials	
Seller	_____
Buyer	<u>T.F.</u>

State of _____)
County of _____) ss

Before me personally appeared _____ to me well known and known to me to be the person(s) described in and who executed the foregoing instrument, and acknowledged to and before me that _____ executed said instrument for the purposes therein expressed.

WITNESS my hand and official seal, this _____ day of _____, 20__.

Signature of person taking acknowledgment (Notary Public)

Name typed, printed, or stamped

(SEAL)

My Commission Expires

This instrument was prepared by:

Prepared by: Dr. Abe Johnson
Church Administrator
-FOR-
Faith Apostolic Christian Tabernacle Services, Inc.
Home Address:
4085 Bothwell Terrace
Tallahassee Florida 32317
850-656-5950

<i>Initials</i>	
Seller	_____
Buyer	<u>TY.</u>

Exhibit "A",

Gadsden County--Property Legal Description

Page 1 of 1

	<p>Gadsden County Property Appraiser's Office Clay VanLandingham, CFA COUNTY APPRAISER</p>	<p>168 CALHOUN ST QUINCY, FL 32353-0585 PH (904) 627-7105 FAX (904) 627-0396</p>
<p>COMPLETE LEGAL DESCRIPTION FOR PARCEL 1-33-4N-6W-0000-00442-0000</p>		
<p>DB 91, P. 104-DB 107, P. 4- COMM. AT SWC OF E1/2 OF SE1/4 RUN N. 0° 45' W. 365.4 FT. TO BEGIN, N. 0° 45' W. 78.1 FT., N. 87° 45' W. 297 FT., N. 11° 50' E. 377.5 FT N. 0° 45' W. 250 FT., N. 89° 15' E. 210 FT., N. 0° 45' W. 589 FT., N. 89° 15' E. 700 FT., S. 45° E. 365 FT., S. 70° 36' E. 660.4 FT., S. 0° 45' E. 590.5 FT., N. 70° 36' W. 660.4 FT., S. 0° 45' E. 353.5 FT., S. 89° 15' W. 700 FT. TO THE P.O.B. LESS PART TO S.R.D. PER OR 65 P 388 IN SECTION 33-4N-6W.</p>		

	Initials
Seller	_____
Buyer	<u>TV</u> _____

Exhibit "B",

Disclosure of Information on Lead-Based Paint and/or Lead-Based Paint Hazards

Lead Warning Statement

Every Buyer of any interest in residential real property on which a residential dwelling was built prior to 1978 is notified that such property may present exposure to lead from lead-based paint that may place young children at risk of developing lead poisoning. Lead poisoning in young children may produce permanent neurological damage, including learning disabilities, reduced intelligence quotient, behavioral problems, and impaired memory. Lead poisoning also poses a particular risk to pregnant women. The seller of any interest in residential real property is required to provide the Buyer with any information on lead-based paint hazards from risk assessments or inspections in the seller's possession and notify the Buyer of any known lead-based paint hazards. A risk assessment or inspection for possible lead-based paint hazards is recommended prior to purchase.

Seller's Disclosure

(a) Presence of lead-based paint and/or lead-based paint hazards (Check (i) or (ii) below):

(i) _____ Known lead-based paint and/or lead-based paint hazards are present in the housing (explain):

(ii) _____ Seller has no knowledge of lead-based paint and/or lead-based paint hazards in the housing.

(b) Records and reports available to the Seller (Check (i) or (ii) below):

(i) _____ Seller has provided the Buyer with all available records and reports pertaining to lead-based paint and/or lead-based paint hazards in the housing (list documents):

(ii) _____ Seller has no reports or records pertaining to lead-based paint and/or lead-based paint hazards in the housing.

Purchaser's Acknowledgment (initial)

(c) _____ Purchaser has received copies of all information listed above.

(d) _____ Purchaser has received the pamphlet Protect Your Family From Lead In Your Home.

(e) Purchaser has (check (i) or (ii) below):

(i) _____ received a 10-day opportunity (or mutually agreed upon period) to conduct a risk assessment or inspection for the presence of lead-based paint and/or lead-based paint hazards; or

(ii) _____ waived the opportunity to conduct a risk assessment or inspection for the presence of lead-based paint and/or lead-based paint hazards.

Agent's Acknowledgment (initial)

(e) Agent has informed the Seller of the Seller's obligations under 42 U.S.C. 4852d and is aware of his/her responsibility to ensure compliance.

Certification of Accuracy

The following parties have reviewed the information above and certify, to the best of their knowledge, that the information they have provided is true and accurate.

Seller Date Seller Date

Purchaser Date Purchaser Date

Agent Date Agent Date

December 23, 2009

Gadsden County School Board
201 M.L. King Jr. Blvd.
Quincy, FL 32351

To Whom It May Concern:

I, Minister Preston Gardner, am the president of an organization known as The Sons Of God Ministry. The ministry was developed June 6, 2007 and has been operating for approximately three years by volunteers of local communities. The activities of the program is to proclaim the gospel of Jesus Christ; to seek and meet the spiritual, financial, charitable, and physical needs of the community to the glory of God. Another focus and important activity of the organization is to maintain a food pantry to feed individuals and/or families in need.

These services will be provided in the City of Chattahoochee, and many other municipalities in the Panhandle area. This program is very beneficial to Chattahoochee and surrounding cities alike. Through this food ministry our volunteers were able to feed approximately a thousand people within a month in Chattahoochee alone. The Sons Of God Ministry intends to continue servicing this community and others with spiritual assistance through ministering and much needed nutrients with the food that is donated to the citizens. As you may already be aware, a location known as Happy Town in the City of Chattahoochee has a very high poverty level. This area along with other neighboring communities and cities are in much need of this type of assistance.

For these reasons, I'm requesting permission to continue operating in the classroom at Southside Elementary School in Gadsden County. I, Preston Gardner, consider it an honor to share the lease with Pastor Yates. I agree to comply with any and all of the lease requirements of the Gadsden County School Board.

Thanks in advance for all of your time, consideration and generosity in this matter.

Sincerely,



Minister Preston Gardner

December 15, 2009

Mr. Isaac Simmons, Jr.
Gadsden County School Board Commissioner
35 Martin Luther King Boulevard
Quincy, Florida 32351

Re: Old Southside School
Chattahoochee, Florida 32324

Dear Mr. Simmons:

This letter comes to respectfully request your assistance as well as the Gadsden County School Board to assist me in obtaining continued use of the Old Southside School for my Outreach Ministry for the Community.

Over the past twelve years, I have continually helped the people in Chattahoochee, Greensboro, Hardaway, Mt. Pleasant, Gretna, and Quincy. I have even assisted several areas in Jackson County. My ministry consists of clothing, food, small appliances, household items, and some toys for the children; especially when the homes are lost due to fire, just people in everyday need.

This year along, I have continuously assisted families through Social Workers, as well as on my own that was either burned out, lost their homes/apartment, or the ones that basically live on the street in the Happy Town area, etc.,

Many times, my daughter Deyira and I have prepared full course meals for the men and women in Happy Town on the streets. When they did not come and get the food, my daughter and I prepared the plates and took the food to them.

During the summer months, I would go to McDaniel, or IGA, and buy bottled water, Oscar Mayer Hot Dogs and Oscar Mayer Bologna, Hellmann's Mayonnaise, French's Mustard, Sara Lee or Sunbeam Bread, and leave it with them to prepare their own meals. I named the items simply because I believe that if God wants us to have the best, then I think no less than the individuals who are out on the street.

Page Two

Also, this past winter, I bought and carried out to Chattahoochee, Elementary School approximately 70 pair's of gloves and gave them to the principal to pass out to the children as they were needed.

I have always had a heart for the people and I will continue to do so regardless of the circumstances. Some of the programs I have done in my Ministry are:

Baby Think It Over Program – This is a program where I was assisted a few years back with the computerized babies and pass them out to teens for 48 hours to discourage early teen age pregnancy. Once these babies are programmed to cry to be changed or fed at a specific time, they will not stop until they are changed or fed, etc.

Piano Lessons – Through the assistance of Mr. Reginald Ray, I was able to offer piano lessons to the children in the community for only \$10.00 per week/per lesson.

Family Night – On Friday nights, I would have family/Christian/Educational based movies for the children and parents. The majority of the time, the children would be dropped off, and I would have to take them home. They would have popcorn, candy bars, juice or soda's etc. And after the movie I would ask them questions to increase their family values.

I also had sleepovers with the children from Friday nights, until Saturday Afternoon. The children would bring their sleeping bags, blankets, and pillows; and my daughter and I would prepare fried chicken, hot dogs, hamburgers, taco's french fries and juice, sodas, etc.,

We also had a **Youth Community Choir**, from the ages of 7 years to 16 years old. The children were taught parts, such as soprano, alto, and tenor.

I also have a **Biblical Book Ministry**. I cannot begin to tell you how many Bibles from the age of two, to youth, to teens, to young adults and adults, that I have given away, and I still do. Also, Bible Covers, books on dating, marriage, and education, covering various topics, etc.

Page Three

The services that I have are not very dressed-up, as I do not want the individuals that need help to feel uncomfortable, so we basically dress casual.

I often think about how we as human beings take so much for granted. The Community passes by these individuals on a daily basis, never giving thought to their daily needs, both from a physical aspect as well as spiritual.

I do not think that most of these individuals want to be out on the street, but we as Christians have to continue to show them that there is a better life.

If we would just think about how many times in a run of a day, that we past by these people and never even send a prayer or a concern their way. We pass by them on our way to work, to the grocery store, to visit friends, and most of all on our way to Church, and back again! But our spiritual instinct never tells some of us that there are cries for help in those young people. They are lost, and do not know their way back, and it is up to us to show them.

I have had many young women to come to my ministry for prayer and assistance. The world look at them for being out on the streets for one reason, or another, but they are out on the streets because they could not deal with being sexually molested by the mother's boyfriend from age 8 years to age 16. When the molestation began, the child told her mother, but the mother did not believe her, and beat her. Therefore, this man continued to rape this child because he would tell her, if you tell your mama, she's not going to believe you, and she will beat you again.

Some molested by their own father(s), and they no longer know how to contend with real life; and they feel that their only way out is to drink and take drugs.

Let us not forget some of the young men; the same thing has happened to some of them also. You would not think that so much goes on in such a small community, but it does!

Page Four

Old Southside School means a lot to me. I attended 1st through 8th grade there. The Principal, Mr. Homer James Smith gave us a legacy to always remember, and to hold on too. I do not know how he accomplished some of the things that he did for us. I remember going with Mr. Smith several times, along with other students to Chattahoochee High School to pick up their old books, because they had received new ones.

I remember that we had a typing class with at least a dozen of typewriters. We also had our own little ROTC Class. Mr. Clarence Bryant would march us up and down the road. We had a Glee Club, and we would send at the various churches.

I still remember our Alma Mater Song that Mr. Smith wrote for us:

Our School to us is like a beak of light
That reaches out and guide us through the night

When trouble rise and fears we know
To our School's sheltering ports we go

All through the years, we've loved and honored you
Always will cherish our colors too

Dear Old Southside, We love you
Ever to our colors, we will always be true

Though we may roam, and travel afar
You dear School, will be our shining star
Will be our shining star

I was able to do a Surprise Appreciation for Mr. Smith with the help of his wife, before he passed away. A lot of the old Teachers and students came for this celebration. This man made an imprint in the lives of so many children.

I too, believe in making a imprint/difference whenever and however I can. I remember when the schools were first integrated.

Page Five

There was not a bus to come from St.James Community to Chattahoochee High School due to not enough children wanting to attend after the school was to be integrated. My parents paid someone for three years to take me too and from school to Chattahoochee High.

I am in the process of regenerating the Baby Think It Over Program, again. This time it will be my responsibility. I want to be able to purchase the various babies such as Asian, Hispanic, African American and Caucasian. Also the babies with the Shaken Syndrome, Prenatal Drug Exposure, and the Prenatal Alcohol Exposure.

These normal babies looks and feel real and weighs 6.5 pounds. The babies cry for the proper care, and even require proper head and neck support, as well as it will tell if these babies have even been shaken when they return from a weekend visit. There is an array of sensors that detects the babies proper positioning.

These teenagers cannot prop a bottle in these babies' mouths and walk away, as the sensors in these babies' demands that they are held, burped, bottle fed, diaper changed and rock. The babies even coo at the end of a successful care event for positive reinforcement.

I also want to implement classes with these young people so that when they take the baby home, they will know how to care for them, as they are extremely expensive.

I also want to purchase Pregnancy Simulation's which a teenager wears to look like they are 9 months pregnant. This curriculum covers the nine month development of the fetus as well as the physical, financial, and social effects of a pregnancy.

Another program I would love to implement is the PreventPak Addiction Simulator. This is a cigarette smoking program/curriculum and a take home smoking refusal simulation. Also, the teen participants learn what it means to have an addiction and get true to life practice in refusing the peer pressure to smoke.

We as mothers, fathers, grandparents, uncles, aunts and other related relatives know that these are much needed programs in the community.

Mr. Simmons, there is so much work to be done. And my request is that you and the Board allow me to continue to use this building until you decide what you will do with it.

Thanking you in a advance,

Pastor Lerther Jones Yhap

/ljy

CTE Classroom Packages

NEW!
Perfect
addition to your
existing program
of study.

CTE Classroom Packages provide students with relevant information and skills for the future. Specific pathways are explored through activities, career-related content, and hands-on simulations/demonstrations using Realityworks interactive technology and curriculum.

Instructor Guides help you choose activities and lessons from relevant sections of each curriculum to meet the standards, course objectives, and essential knowledge and skills for each specific pathway.



See p. 5

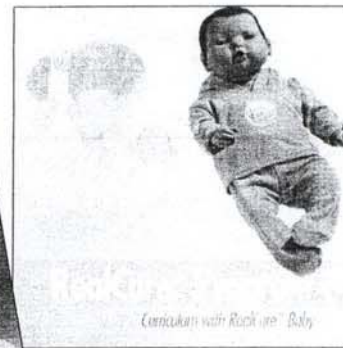

See p. 4



Therapeutic Services

Infant Development and Health: From Conception through the First Year of Life

Content:

- ★ Biology specific to human structure and function
- ★ Personal and community health related to fetal development
- ★ Empathy and communication skills when working with infants
- ★ Project- and problem-based healthcare practices
- ★ Academic, communication and technical skills within the industry
- ★ Quality of care and services

Sample Careers:

- ★ Home Health Aide
- ★ Licensed Practical Nurse

Interactive Simulation Products & Curricula Included in Each Package

	Infant Development and Health	Introduction to Early Childhood Services	Infant Issues for Family and Community Services	Working with Infants and Toddlers	Introduction to Parenting
Pathway-Specific Instructor Guide	X	X	X	X	X
Basic Infant Care Curriculum	X	X	X	X	X
RealCare Curriculum					X
Infant Simulators & Control Center Software	X	X	X	X	X
Understanding Prenatal Alcohol Exposure-Curriculum & Manikin	X	X	X	X	X
Understanding Prenatal Drug Exposure-Curriculum & Demonstrator	X	X	X	X	X
Understanding Shaken Baby Syndrome-Curriculum & Simulator	X	X	X	X	X
Pregnancy Simulation-Curriculum & Simulator	X	X	X		X

Packages available in small, medium and large. Contact your Product Consultant for pricing.

Realityworks®
Live it. Learn it.™

800.830.1416 • 715.830.2040
realityworks.com

Classroom Packages Qualify for Perkins Funding!

Talk to your Product Consultant for pricing and detailed curriculum/package information.

Storage Options

NEW
in 2009!



5-Baby Mobile Storage/Charging Case

Convenience combined with maximum strength for charging, storing and transporting RealCare Babies and supplies.

- ★ High density polyethylene case with molded-in bumpers
- ★ Inline wheels
- ★ Custom foam inserts for up to five RealCare Babies
- ★ Generous storage area for bottles, diapers, cords and other program necessities for five infant simulators
- ★ Lock-and-key secure storage

5-Baby Mobile Storage/Charging Case

Item #10168110 \$999

Mobile Storage/Charging Carts

Conveniently charge Babies and store them safely in this attractive cabinet on wheels. Available in two sizes. Take your program anywhere!

- ★ Wood accents and durable metal doors, front and back
- ★ Easy-to-grip steering handles for portability
- ★ Lockable wheels and retractable electrical cord
- ★ Lock-and-key secure storage

Convenient, portable
and secure!



Small RealCare Cart

Stores and charges up to 20 Babies with extra drawer for supplies.

Dimensions: 46"H x 45"W x 28"D (1.17m x 1.14m x .71m)

20-Baby Storage/Charging Cart

Item #10168100 \$4,499

Large RealCare Cart

Stores and charges up to 30 Babies with extra drawer for supplies.

Dimensions: 46"H x 54"W x 28"D (1.17m x 1.37m x .71m)

30-Baby Storage/Charging Cart

Item #10168105 \$5,499

Note: Carts are a special order item. Freight costs are quoted separately. Allow approximately 8-10 weeks for delivery. Babies sold separately.

Realityworks

Live it. Learn it.

800.830.1416 • 715.830.2040

realityworks.com

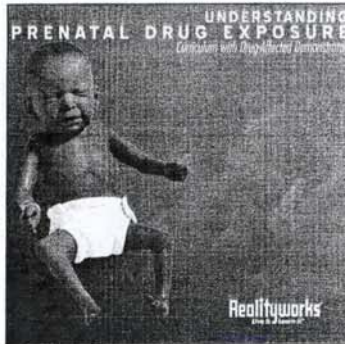

See p. 15

See p. 15

See p. 16

See p. 15



Early Childhood Development Services

Introduction to Early Childhood Services

Content:

- * Physical, emotional, intellectual, and social development of the child from conception through toddler years
- * Practical application of infant care skills
- * Health, safety, and emergency procedures

Sample Careers:

- * Childcare worker
- * Nanny
- * Preschool teacher



Family and Community Services

Infant Issues for Family and Community Services

Content:

- * Personal and community health related to fetal development
- * Risks and results of prenatal drug and alcohol exposure
- * Implications of Shaken Baby Syndrome
- * Methods for preventing Shaken Baby Syndrome
- * Empathy and communication skills for parents/guardians of infants
- * Academic, communication, and technical skills within the industry

Sample Careers:

- * Child Life Educator
- * Human Services Worker
- * Social and Human Services Assistant



Teaching/Training

Working with Infants and Toddlers

Content:

- * Human Growth and Development—particularly infant and toddler development stages
- * Empathy and communication skills with infants and toddlers
- * Resources and the importance of play
- * Feeding and nutrition
- * Tracking and communicating a child's schedule of activities
- * Health, safety, and emergency situations
- * Providing basic care for infants

Sample Careers:

- * Childcare Worker
- * Child Life Specialist
- * Early Childhood Teacher

Family and Community Services

Teaching/Training, Administration and Administrative Support, Professional Support Services

Introduction to Parenting

Content:

- * Financial and social changes with parenting
- * Fetal development
- * Prenatal care
- * Health and safety
- * Infant and toddler developmental stages
- * Nurturing responsibilities of parents and educators
- * Providing basic infant care
- * Communication, resource management and problem solving

Sample Careers:

- * Nanny
- * Preschool Teacher
- * Social and Human Services Assistant
- * Parent Educator

Professional Development

Clusters

- 1- Human Services
- 2- Health Sciences
- 3- Education and Training

Pathways

- 1- Early Childhood Development
- 2- Teaching / Training
- 3- Family and Community Services
- 4- Therapeutic Services

Topics

- 1- fetal health & development
- 2- personal & community health
- 3- health & safety
- 4- infant care skills

Knowledge and Skills

- 1-
- 2-
- 3-



Interactive, Personalized and Feature-Rich Facilitator Training

Get the greatest value from your investment and increase effectiveness!

Your training day includes:

- ★ Intensive curriculum information
- ★ Meeting educational standards
- ★ Simulation training
- ★ Performance measurement and customized rubrics
- ★ Tips, tricks and helpful hints

You'll get hands-on experience using infant simulators and software, helping you master the program and immediately provide skill-building experiences for your students.

Our trainers come to you!

Dates are subject to the availability of trainers. Call your Product Consultant for more details. For information and availability outside the U.S., please contact our international department or your nearest distributor of Realityworks products.

Coming in
2009!

Best Practices by Subject Area

Customize your RealCare Facilitator Training by integrating topics relevant to your program of study. You'll receive intensive, hands-on training in the RealCare Program, but you'll also explore effective strategies and best practices to immediately enhance teaching in the following subject areas:

- ★ Life skills training
- ★ Early childhood development
- ★ Parenting
- ★ Core academic skills
- ★ Career exploration

"I was looking forward to this workshop. It was above and beyond—more than expected!"

*Trish Lectora
Information Technology High School
Long Island City, New York*

"I now know I will be successful in teaching with RealCare Baby!"

*Judy Jurinko
Hilton Head Island High School
Hilton Head Island, South Carolina*

Keep Babies Safe From Harm

Hard-hitting demonstrations for child abuse prevention



A powerful combination!
Buy all 3 in a combo pack.

The FAS Manikin and the Drug-Affected Demonstrator are powerful tools to demonstrate the reality of drinking and doing drugs during pregnancy. The students are visibly moved and share their sadness in seeing these babies and listening to the cries and tremors of the Drug-Affected Demonstrator.

Julie DeShetler
Life Skills Instructor, Wedgewood Christian Services
Grand Rapids, Michigan

Witness the consequences of unhealthy choices made by a parent or caregiver. Personal experiences with these distressed infants provide effective and memorable lessons.

Easily integrate with early childhood education, parenting preparation, and training for health occupations—or use as supplements to the RealCare Program.

Combo Pack
Shaken Baby Syndrome Simulator, Drug-Affected Demonstrator and Fetal Alcohol Syndrome Manikin
Item #11010105\$999.00

Realityworks
Live it. Learn it.

800.830.1416 • 715.830.2040
realityworks.com

Understanding Shaken Baby Syndrome with Shaken Baby Syndrome Simulator



Just one thoughtless shake can cause permanent brain damage or death

Simulation begins with the cries of an inconsolable infant.

Accelerometers inside the head measure the force on the brain when shaken. Corresponding LED lights show the damage to specific areas of the brain in real time. The simulator's cries stop abruptly—for all the wrong reasons. Curriculum emphasizes the need for a plan to cope with an inconsolable infant.

Operates by on/off switch.

Contents:

- Simulator, t-shirt, cloth diaper,
- (4) C batteries,
- Curriculum CD,
- Limited one-year warranty

National Standards Met:

- Family and Consumer Sciences: 4, 6, 7, 12, 13, 15
- Health Education: 1-8

Curriculum Highlights:

- Signs & Symptoms of SBS
- Physical Results of SBS-related Brain Injuries
- Planning for Frustration and Stress

Print version sold separately.

Available in Spanish.

Shaken Baby Syndrome Simulator

Item #10510100\$689.00



Understanding Prenatal Drug Exposure with Drug-Affected Demonstrator

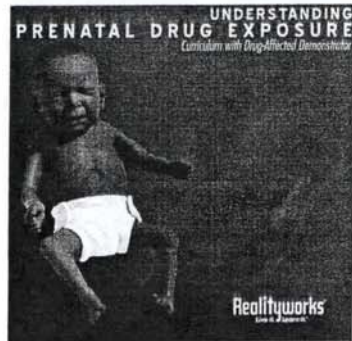

A startling demonstration of the impact of substance abuse on the unborn child

Explore the physical and mental health consequences, feel the withdrawal tremors and hear

the inconsolable cries of a drug-affected infant. Exhibits small size and weight for gestational age, tiny limbs and painful facial expression.

Operates by on/off switch.

Contents:

- Demonstrator, cloth diaper,
- (4) AA batteries,
- Curriculum CD,
- Limited one-year warranty

National Standards Met:

- Family and Consumer Sciences: 4, 6, 7, 12, 13, 15
- Health Education: 1-3, 5-8

Curriculum Highlights:

- Prenatal Drug Exposure's Short- and Long-Term Impact
- Costs of Prenatal Drug Exposure
- A Pregnant Woman and Her Fetus

Print version sold separately.

Available in Spanish.

Drug-Affected Demonstrator

Item #10310100\$329.00



Understanding Prenatal Alcohol Exposure with Fetal Alcohol Syndrome Manikin



A visual reminder of why alcohol should never be used during pregnancy

Based on real FAS infants, this manikin is small for gestational age and exhibits some of the many physical abnormalities

resulting from alcohol use during pregnancy. Explore the external effects, such as small head circumference, narrow eye openings, flat mid-face and more. Also addresses the many cognitive and internal effects, brain damage, organ problems and learning disabilities.

Contents:

- Manikin, cloth diaper,
- Curriculum CD,
- Limited one-year warranty

National Standards Met:

- Family and Consumer Sciences: 4, 6, 7, 12, 13, 15
- Health Education: 1-3, 5-8

Curriculum Highlights:

- Fetal Alcohol Syndrome
- Fetal Alcohol Spectrum Disorders
- How Nutrients, Oxygen and Other Components Reach the Fetus

Print version sold separately.

Available in Spanish.

Fetal Alcohol Syndrome Manikin

Item #10410100\$229.00

Pregnancy Simulation

Simulate the look and feel of third trimester

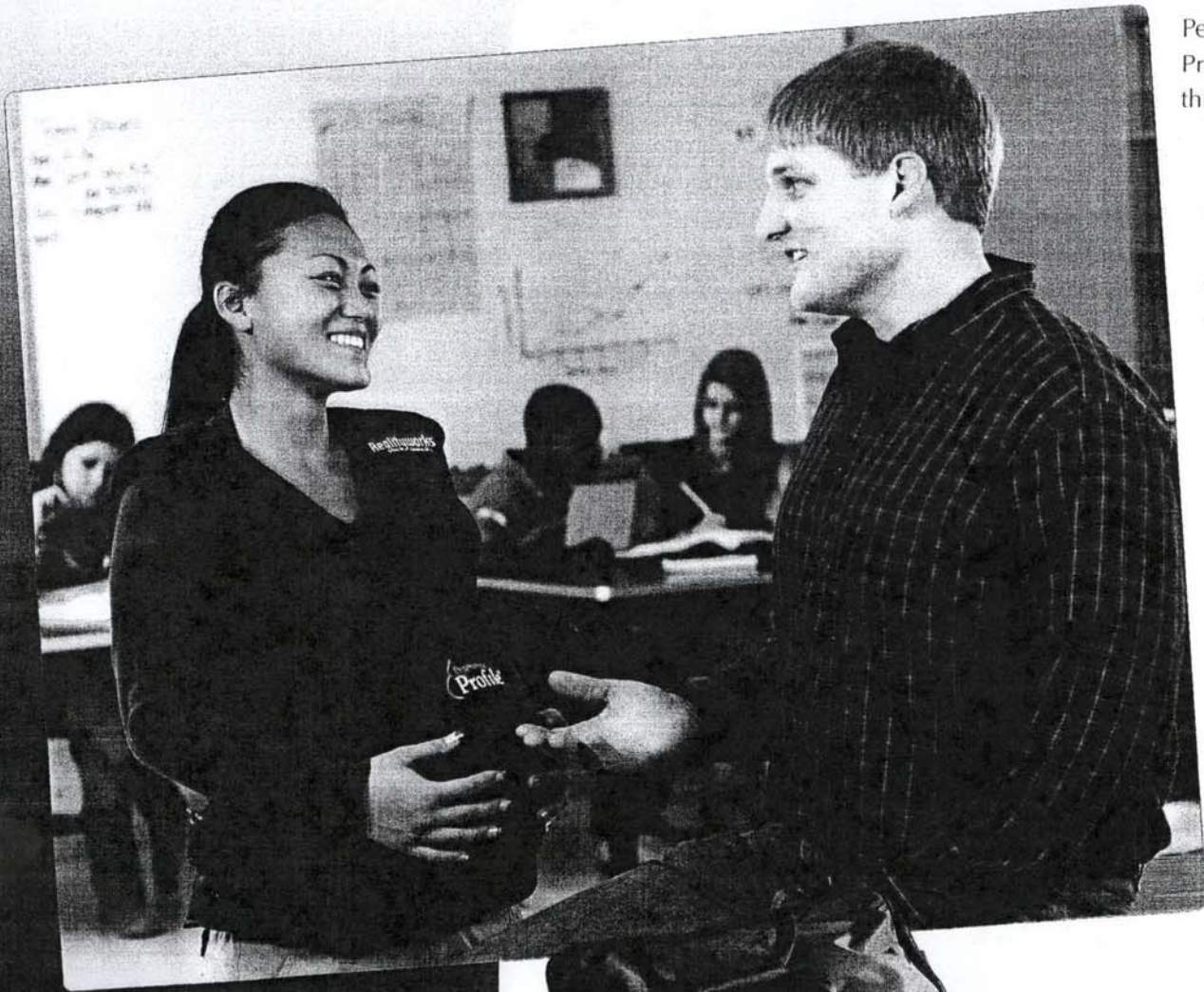

Perfect as a precursor to the RealCare Baby experience, the Pregnancy Profile Vest simulates what it's like to be in the third trimester.

- * Adjustable rib constrictor simulates fetal limb pressure and shallowness of breath
- * Water-filled bladder with suspended weight replicates mild fetal movement and 25 lb. (23 kg) weight gain
- * Weighted bag applies pressure to the user's bladder
- * Corresponding curriculum covers the nine-month development of the fetus as well as the physical, financial and social effects of a pregnancy

Contents:
 Pregnancy Profile Vest,
 Curriculum CD,
 One-size-fits-all embroidered t-shirt,
 Lightweight carrying case,
 Limited two-year warranty



National Standards Met:
 Family and Consumer Sciences: 6, 12, 13, 15
 Health Education: 1-8

Curriculum Highlights:
 Pregnancy Symptoms and Physical Changes
 Fetus Monthly Development
 Parenting in Different Cultures

Print version sold separately. Available in Spanish.

Quantity	Package #	Price
1	10610100	\$499
2	10610105	\$899
4	10610110	\$1,799
10	10610115	\$4,399

"Even the boys want to try it on. Everyone is surprised that pregnancy can be so uncomfortable. My girls say there is no way they want to have a baby anytime soon and the boys are amazed that women can go through so much discomfort. It is an excellent teaching tool."

*Montel Horne, Family and Consumer Sciences Teacher
 Gretna Middle School, Gretna, Virginia*



Vest and components store conveniently in this compact, lightweight carrying case.

Realityworks®
 Live it. Learn it.™
 800.830.1416 • 715.830.2040
 realityworks.com

ySTART Program

with the PreventPak Addiction Simulator

An engaging experience in peer pressure, the power of addiction and the health consequences of smoking.

The ySTART Program is a proactive, standards-based approach to smoking prevention using an innovative curriculum and a take-home smoking refusal simulation.

Participants learn what it means to have an addiction and get true-to-life practice in refusing the peer pressure to smoke.

Contents:

Curriculum with student and instructor materials, full-color overhead transparencies, CD of printable files, Control Center software for data transfer, handheld electronic simulators with voice recognition technology, wristband IDs, docking station for programming, charging and storage.

Curriculum Highlights:

- Tobacco and the Respiratory System
- Tobacco, Health and the Environment
- Tobacco and the Media
- Skills for a tobacco-free life – communication, risky behavior, choices and consequences
- Take-home simulation and smoking refusal
- Reflection and commitment

National Standards Met:

- Family and Consumer Sciences: 6, 12-14
- Health Education: 1-8

Call for pricing.



Give your students a measurable, life-saving experience!

Teaching 21st Century skills with 21st Century technology

The voice of an addicted friend begs: "I'm so stressed! I really need to go smoke."

Participants must say "No!" into the Pak.

Peer voices pressure: "Why not?"

Participants must recite one of their personal ySTART phrases: "I like to play sports."

The voice of reason says: "Every 6 1/2 seconds someone in the world dies because they've used tobacco."

At simulation's end healthy behavior is reinforced: "Your lungs thank you!"



ySTART

Preventpak Settings: ID# Blue 24

preventpak schedule (events/day): 15, 20, 25, 30, 35

start time: July 27, 2007 4:00 pm

price/pack: \$4.47

stop time: July 29, 2007 9:00 pm

awake time: 9:00 am

sleep time: 9:00 pm

smoking simulation length: 2 Days, 5 Hours, 0 minutes

Overall Financial & Life Savings

in simulation	1yr	5yr	10yr
\$10.50	\$1,737.40	\$8,687.02	\$17,374.05
5h 25m	5w 2h 19m	26w 6d 23h	1y 1w 6d

Performance

day	Successfully completed events	# of preventpak events	missed requests
1	5	5	0
2	19	20	0
3	23	25	0
4			
5			
Total	47	50	0

Daily Detail

Day 1
4:00 PM Start Sim
9:00 PM Sleep

Day 2
9:00 AM Awake
12:35 PM Missed Event
9:00 PM Sleep

Day 3
9:00 AM Awake
9:13 AM Missed Event
9:53 AM Missed Event
9:00 PM End Sim

Day 4

Day 5

Class: Health 101
Participant Name: Student

Overall Score: 94%

Includes a personalized printout of the simulation report, with room for instructor comments

LEASE AGREEMENT

This Lease Agreement (this "Lease") is made and entered into this _____ day of _____, 2009, by and between:

- **SCHOOL BOARD OF GADSDEN COUNTY, FLORIDA**
whose mailing address is 35 Martin Luther King, Jr., Boulevard., Quincy, Florida 32351 (hereinafter referred to as "Lessor"), and
- **SEARCHING FOR THE ONE MINISTRIES, INC.**
whose mailing address is 315 Dogwood Drive, Havana, Florida, 32333 (hereinafter referred to as "Lessee").

IN CONSIDERATION of \$10.00 and other good and valuable consideration, the receipt and sufficiency of which is acknowledged, the Lessor and the Lessee agree as follows:

1. Description of Premises

Subject to and upon the terms, provisions and conditions herein set forth, Lessor does hereby lease, demise, and rent to the Lessee and the Lessee does hereby lease, demise and rent from the Lessor the real property and all building improvements described on the attached **Exhibit "A"** (hereafter "the Property" or "Leased Premises").

2. First Right of Refusal

The above property described in Exhibit A is owned by the Gadsden County School Board and is for sale at anytime a buyer should make a proposal or offer prior to, during or after the time frame of this Lease.

If during the term of the Lease (Searching for the One Ministries, Inc.) listed as Lessee, will have a chance to purchase property first. If (Searching for the One Ministries, Inc.) and School Board cannot agree on selling price then property will be sold to (person, group or agency) making offer.

3. Selling Property

If the School Board decides to sell property to another (person, group or agency) during the term of this Lease, (Searching for the One Ministries, Inc.) would like to re-coop some of their cash investment in the property, that helped to enhance the property and made it more attractive for selling.

(a) The School Board agrees to discuss above Item #3 at appropriate time, but does not guarantee there will be a settlement in favor of (Searching for the One Ministries, Inc.).

4. Acceptance of Premises

Neither Lessor nor Lessor's agents have made any representations or promises with respect to the Lease Premises, or this Lease except as herein expressly set forth. The taking of possession of the Leased Premises by Lessee shall be presumptive evidence, as against Lessee, that Lessee has accepted the Leased Premises in their "as is" condition on the date the lease Term commences and that the Leased Premises are suited for the use intended by Lessee and the Leased Premises are in good and satisfactory condition at such time.

5. Term

Subject to and upon the conditions set forth in this Lease or in any exhibit or addendum attached to this Lease, this Lease shall continue in full force and effect for a term of three (3) years from the date of this Lease.

6. Commencement

The Term of this Lease shall begin at 12:01 a.m., on January 4, 2010, and end at midnight, on December 31, 2012, unless sooner terminated as provided in this Lease.

7. Monthly Rent

For the first six (6) months of lease (January 4, 2010 to June 30, 2010) Lessor agrees to allow Lessee to provide documented monthly expense reports to Lessor as support for monthly payment. Prior to and after June 30, 2010, a monthly amount will be agreed upon by both parties in writing and will commence on July 5, 2010. Lessee shall pay all utility costs (electric, gas, fuel oil, phones, security, garbage and water) and all applicable sales and use tax from the beginning of the Lease (January 4, 2010) until it expires or is terminated for cause.

8. Security Deposit

Prior to occupancy, Lessee shall pay to Lessor, as a Security Deposit, the sum of zero dollars (\$0.00). Such deposit, if any shall be required, shall be applied to the last month's Monthly Rental, provided that Lessee shall have performed all of Lessee's obligations under this Lease. The Security Deposit, if any shall be required, shall secure Lessee's obligations specified in this Lease and shall be held and applied as permitted under Florida law.

9. Late Charges and Returned Checks

The Monthly Rental due Lessor under this Lease shall be considered past due for purposes of this Lease if not received by Lessor by the fifth (5th) day of any month during the lease Term. If Lessor has not received any Monthly Rental Payment required by this Lease by the fifth (5th) day of the month it is due, Lessee shall, in addition to the Monthly Rental payment, be obligated and shall pay a service charge of zero dollars (\$0.00). Any other amounts payable to Lessor under this Lease, with the exception of Monthly Rental, shall be considered past due thirty (30) days from Lessor's billing date and, in addition to such payment, Lessee shall pay interest on such

past due payment at the Default Rate of the legal rate set by law for judgments and decrees until it is, or they are, paid. Any check received from Lessee which is returned for insufficient funds or any other reason shall require Lessee to pay Lessor a service charge of thirty five dollars (\$35.00) per returned check.

10. Repairs and Maintenance, Upkeep and Expense by Lessee

Lessee shall, at its own expense, keep and maintain the Leased Premises and appurtenances and every part of them in good order and repair, as provided in this Lease. The School Board is not responsible for any maintenance or repair, connection fees, deposits or any cost associated with upkeep of facility.

Lessee shall make no alterations in, or additions to the Leased Premises without first obtaining Lessor's written consent for such alterations or additions. Additions or improvements which shall be made by either Lessor or Lessee and attached to the Leased Premises, including carpet, shall be the property of Lessor and shall remain upon and be surrounded with the Leased Premises as part of them at the termination of this Lease, without disturbance, molestation, or damage. Lessee shall promptly notify Lessor of any needed repairs or maintenance. In addition to the foregoing, Lessee will at its own expense, pay for and be responsible for: (a) keeping the grounds mowed and plants, trees trimmed; (b) monitoring all buildings weekly for roof leaks, rotten wood, domestic water leaks and broken windows; (c) repairing any items found in letter (b) above and calling the Director of Facilities at (850) 627-9888 for major areas of concern; (d) do periodic pressure washing of walkway roofs and walkways, paint any areas that need painting; (e) do all custodial work inside and outside of the buildings in order to keep them well maintained and looking good.

11. Use of Premises

The Leased Premises shall be used and occupied by Lessee solely for the purpose of Lessee's non profit organization and related uses, unless other uses are specifically stated and authorized by Lessor. The Leased Premises shall not be used for any illegal purpose nor be used in violation of any valid law or regulation of any governmental body, nor in any manner to create any nuisance or trespass.

12. Quiet Enjoyment

If Lessee shall pay the rent stated in this Lease and all other amounts to be paid by Lessee to Lessor, and faithfully keeps, performs and observes all of the covenants, agreements and conditions herein stipulated, Lessee shall have, at all times during the Term of this Lease, the peaceable and quiet enjoyment of the Leased Premises without hindrance of Lessor, or any other person acting lawfully by or through Lessor, subject, however, to the terms of this Lease.

13. Assignment and Subletting

Lessee may not, without the prior written consent of Lessor, assign this Lease or any interest under it, or sublet the Leased Premises or any part of them, or permit the use of the Leased

Premises by any party other than the Lessee. Consent to assignment or sub-lease shall not release Lessee from any of its obligations under this Lease and shall not destroy or waive this provision and all later assignments and sub-leases, if any, shall likewise be made only upon the prior written consent of the Lessor. Sub-tenants or Assignees shall become liable to the Lessor for all obligations of the Lessee hereunder.

14. Property of Lessee

Lessee may, if not in default hereunder, prior to the expiration of this Lease, or any extension of it, remove all fixtures and equipment which it has placed in the Leased Premises, provided Lessee repairs all damages to the Leased Premises caused by such removal, normal wear and tear excepted. However, the Lessor shall have at all times a valid first lien, to secure all rentals and performances by the Lessee of each and all of the covenants, agreements and conditions of this Lease, upon all of the personal property of the Lessee situated in the Leased Premises and such property shall not be removed without the written consent of the Lessor until all arrearage in rent as well as any and all other sums of money due or to become due hereunder shall first have been paid and discharged. Further, the lien herein granted may be foreclosed in the manner provided by law. The statutory lien for rent shall not be waived or released except by the express written release by Lessor. If the Lessee shall fail to timely remove all its property from the Leased Premises upon termination of this Lease for any cause whatsoever, Lessor may, at its option, remove the same in any manner the Lessor shall choose, store such property without liability to the Lessee for loss thereof, and the Lessee agrees to pay the Lessor on demand any and all expenses incurred by such removal and storage, including court costs and attorney fees and storage charges for any length of time the property shall be in the Lessor's possession. The Lessor may, at its option, without notice, sell such property or any part of it at private sale, without legal process, for such price or prices as the Lessor may obtain. The Lessor may apply the proceeds of any such sale to any amounts due under this Lease from the Lessee to the Lessor, after paying the expenses incident to the removal, storage, and sale of such property.

15. Damage or Theft of Personal Property

Lessee agrees that all personal property and fixtures brought into the Leased Premises shall be at the risk of the Lessee only and that the Lessor shall not be liable for theft or for any damages occasioned by acts of co-tenants, or other occupants of the Office Building in which the Leased Premises are located, or any other person, except for employees and agents of Lessor acting within the scope of their employment.

16. Service of Notice

The Lessee hereby appoints as its Agent to receive the service of all dispossessory or distraint proceedings, legal notices and notices required under this Lease, Schell Collins, and if there is no person in charge or occupying the Leased Premises, then such service or notice may be made by attaching the same on the main entrance to the Leased Premises and sending a copy to the Lessee at the address provided in this Lease or at such other address as may have been provided in writing by Lessee to Lessor for such purpose. Any change in Agent must be reported to Lessor in five (5) days or less.

17. Severability

If any clause or provision of this Lease is illegal, invalid or unenforceable under present or future laws effective during the Term of this Lease, then and in that event, it is the intention of the parties hereto that the remainder of the provisions of this Lease shall not be affected thereby, and it is also the intention of the parties to this Lease that in lieu of each clause or provision of this Lease that is illegal, invalid or unenforceable, there be added as a part of this Lease a clause or provision as may be possible and be legal, valid and enforceable. If such invalidity is, in the sole determination of Lessor, essential to its rights, Lessor has the right to terminate Lease on written notice to Lessee.

18. Cumulative Rights

All rights, powers and privileges conferred hereunder upon the parties hereto shall be cumulative but not restrictive to those provided by law.

19. Attorney's Fees

If any rent owing under this Lease is collected by or through an Attorney at Law, Lessee agrees to pay Lessor's reasonable attorney's fees and court costs. If the Lessor or the Lessee defaults in the performance of any of the covenants of this Lease and by reason thereof the Lessor or the Lessee employs the services of an attorney to enforce performance of said covenants, the non-prevailing party shall pay the reasonable attorney's fees and expenses and costs incurred by the prevailing party in the enforcement of any remedy available to it.

20. No Estate in Land

This Lease shall create only the relationship of landlord and tenant between Lessor and Lessee. No estate shall pass out of Lessor. Lessee has only a usufruct, not subject to levy and sale, and not assignable by Lessee except by Lessor's consent, which consent Lessor may withhold in its sole and absolute discretion.

21. Parties

"Lessor" as used in this Lease shall include the first party, its successors and assigns entitled to the premises. "Lessee" shall include the second party, its heirs and representatives, and if this Lease shall be validly assigned or sub-let, shall include also Lessee's assignees or sub-lessees, as to the premises covered by such assignment or sublease. The words "Lessor" and "Lessee" shall include male and female, singular and plural, corporation, partnership or individual, as they fit the particular parties.

22. Utilities and Janitorial Services

Lessee will, at its own expenses, pay all utility charges to the Leased Premises, including electricity for lights and power, telephone, gas, water or other utility services to or for the use of the Lessee in the Leased Premises.

23. Remedies of Lessor for Non-Compliance by Lessee

In the event: (a) the rent specified herein is not paid at the time and place when and where due; (b) the Leased Premises shall be deserted or vacated; (c) the Lessee shall fail to comply with any term, provision, condition or covenant of this Lease, other than the payment or rent, or any of the Rules and Regulations now or hereafter established for the management of the Leased Premises of which the Leased Premises are a part; (d) any petition is filed by or against Lessee under any section or chapter of the Federal Bankruptcy Code as amended; (e) Lessee shall become insolvent or make a transfer to defraud creditors; (f) Lessee shall make an assignment for the benefit of creditors; or (g) a receiver is appointed for a substantial part of the assets of Lessee; and Lessee shall not cure such default(s), with the exception of rental default as provided for above, within thirty (30) days after notice to the Lessee of such failure to comply, and upon the occurrence of any one or more of the foregoing Lessor shall have the option to proceed according to one or more of the following courses of action:

(a) Terminate this Lease, in which event Lessee shall immediately surrender the Leased Premises to Lessor, and if Lessee shall fail to do so, Lessor may, without further notice and without prejudice to any other remedy Lessor may have for possession or arrearage in rent, enter upon the Leased Premises and expel or remove Lessee and its property, by force if necessary, without being liable to prosecution or any claim for damages therefore, and Lessee agrees to indemnify Lessor for all loss and damage which Lessor may suffer by reason of such termination, whether through inability to relet the Leased Premises, or through decrease in rent or otherwise; and/or

(b) Declare the entire amount of the rent which would become due and payable during the remainder of the Term of this Lease to be due and payable immediately, in which event, Lessee agrees to pay the same at once, together with all rents theretofore due, as provided herein. The acceptance of such payment by Lessor shall not constitute a waiver of any failure of Lessee thereafter occurring to comply with any term, provision, condition or covenant of this Lease; and/or

(c) Lessor, without terminating this Lease, upon Lessee's breaching this Lease, inclusive of abandonment, may at Lessor's option enter upon the Leased Premises by force, if necessary, without being liable for prosecution, and rent the Leased Premises at the best terms obtainable by reasonable effort. Lessee shall be liable to Lessor for the deficiency, if any, between Lessee's rent hereunder and the price obtained by Lessor on reletting.

Pursuit by Lessor of any of the foregoing remedies shall not preclude the pursuit of any of the other remedies herein provided or any other remedies provided by law.

No agreement to accept a surrender of the Leased Premises shall be valid unless the same be made in writing and subscribed by the Lessor.

The mention in this Lease of any particular remedy shall not preclude the Lessor from pursuing any other remedy the Lessor might have, either in law or in equity.

In case it should be necessary or proper for Lessor to bring any action under this Lease, or to consult with an attorney concerning or for the enforcement of any Lessor's rights under it, then Lessee agrees in any and such case to pay to Lessor a reasonable attorney's fee.

The receipt by the Lessor of rent with knowledge of the breach of any covenant contained in this Lease shall not be deemed a waiver of such breach.

24. Holding Over

In the event of holding over by the Lessee subsequent to the expiration or other termination of this Lease and without regard to Lessor's acquiescence or consent, Lessee shall pay as liquidated damages a monthly rent equal to two hundred percent (200%) of the monthly rent payable immediately prior to such expiration or termination of this Lease for the duration of such holdover period. Additionally, during such holding over with Lessor's acquiescence and without any express agreement of the parties, the Lessee shall be a tenant on a month to month basis which tenancy shall be terminated absolutely and without remedy upon thirty (30) days prior to written notice of such intent by either party. There shall be no renewal of this Lease by operation of law.

25. Effect of Termination of Lease

No termination of this Lease prior to the stated termination of it, by lapse of time or otherwise, shall affect Lessor's right to collect rent for the period prior to the termination thereof.

26. Real Estate Taxes

Lessee shall pay all real property ad valorem taxes on the Leased Premises as soon as the amounts have been established and not later than November 30th of each year the property is leased.

27. Governmental Requirements

Lessee agrees at its own expense, to comply with all requirements of any legally constituted public authority concerning the use of the Leased Premises.

28. Eminent Domain

If the whole of the Leased Premises or such thereof as will make the Leased Premises or parking area unusable for the purpose herein leased, be condemned by any legally constituted authority for any public use or purpose, then in either of said events the Term hereby granted shall cease from the time when possession thereof is taken by public authority, and rent shall be accounted for as between Lessor and Lessee as of that date. Should any public taking render only a portion of the Leased Premises unusable, such condemnation shall in no way affect the respective rights and obligations of Lessor and Lessee hereunder. It is expressly agreed that the Lessee shall not have any right or claim to any part of any award to or received by the Lessor for such taking. As used herein, "unusable" shall be in the reasonable judgment of the Lessee.

29. Destruction of Premises

If the Leased Premises are totally destroyed (or so substantially damaged as to be untenantable) by storm, fire earthquake or other casualty, at the option of Lessor this Lease shall terminate as of the date of such destruction or damage, and rental shall be accounted for as between Lessor and Lessee as of this date. The Lessor, within twenty (20) days of such destruction or damage, shall give Lessee notice as to its intent to reconstruct. Failure to do so shall give Lessee the option to cancel this Lease. If Lessor elects to reconstruct, the rent shall be abated during the construction term and such construction shall not exceed ninety (90) days, or Lessee may cancel this Lease.

If the Leased Premises are damaged but not rendered wholly untenantable by any such casualty or casualties, rental shall abate in such proportion as the use of the Premises has been destroyed until the Lessor has restored the Leased Premises to substantially the same condition as before the damage, whereupon full rental shall recommence. Nothing contained herein shall require Lessor to make such restoration if not deemed advisable in its judgment. If Lessor fails to provide notice of the option to reconstruct within twenty (20) days of the occurrence, Lessee may at its option, cancel this Lease. If the Leased Premises are not restored within ninety (90) days of the occurrence, Lessee may at its option cancel this Lease.

30. Insurance

Lessee shall, at its sole expense, maintained in full force and effect during the term hereof public liability and property damage insurance in an amount not less than one million dollars (\$1,000,000.00) single limited combined bodily injury and property damage for each occurrence for coverage of all situations where any person or persons claim bodily injury, death or property damage in or upon the premises. All such insurance policies shall be issued by a reputable company authorized to do business in the State of Florida and reasonably acceptable to Landlord and shall name Lessee, Lessor and any mortgagee of the property as coinsureds as their respective interests may appear, and shall provide for cancellation thereof only after thirty (30) days prior written notice to Lessor and any mortgagee named therein. Lessee shall provide to Lessor and any mortgagee named in such policies with copies thereof. In the event Lessee fails to timely secure and maintain in full force and effect the insurance as required hereunder, the same shall be deemed an event of default and Lessor, in addition to any other remedies provided in this agreement, shall have the right to secure said insurance at the expense of Lessee, and any funds so advanced shall be immediately due and payable by Lessee to Lessor, and shall bear interest from the date of advance at the highest rate of interest allowed by law to be charged on the amounts then due to Lessor. Lessee may maintain such insurance on its leasehold improvements, trade fixtures and items of personal property as Lessee deems appropriate.

31. Entry of Lessor

Lessor may enter the Leased Premises at reasonable hours to exhibit the same to prospective purchasers or tenants, to inspect the Leased Premises to see that the Lessee is complying with all of its obligations hereunder, to make repairs required by Lessor under the terms hereof, or to make repairs to the Office Building.

32. Indemnification

Lessee agrees to indemnify and hold Lessor harmless from any and all liability and damages, including attorneys' fees, for claims of others for injuries to persons or property occurring in or upon the premises arising out of the use, occupancy or operation of said premises by Lessee, its officers, employees, agents, guests and invitees, except such damage or liability as is caused by the negligent, intentional, willful acts of Lessor.

33. Signs

Lessee shall not place, construct, erect, affix or attach any sign, billboard or other advertising material to the exterior of the premises without the prior written consent of Lessor as to the location, size, material to be used, design, and substance of advertising material to be contained on the sign. Lessor may withhold its consent for purely aesthetic reasons and if it determines in its sole discretion that said advertising media and/or proposed sign is not in keeping with Lessor's advertising scheme for the center. All costs associated with the purchase and installation of approved signage shall be borne by Lessee.

34. Waste

Lessee shall not commit waste or permit waste to be committed in or upon the premises, and at the termination of the Lease shall surrender and deliver the premises to Lessor in as good condition as the same were at the time of commencement of the term hereof, normal wear and tear excepted.

35. Captions

The captions of each paragraph and heading hereof are added as a matter of convenience only and shall be considered to be of no effect in the construction of any provision of this Lease.

36. Time of Essence

Time is of the essence of this Lease.

37. Entire Agreement

This Lease and any amendments, attachments and riders to it contain the entire agreement of the parties and no representations, inducements, promises or agreements, oral or otherwise, between the parties not embodied herein shall be of any force or effect. No failure of the Lessor to exercise any power given the Lessor hereunder, or to insist upon strict compliance by the Lessee of any obligation hereunder, and no custom or practice of the parties at variance with the terms hereof shall constitute a waiver of the Lessor's right to demand exact compliance with the terms hereof. This Lease may be amended by the parties, but any such amendment shall only be effective and enforceable if it is in writing and signed by both parties.

IN WITNESS WHEREOF, the parties have executed the Lease Agreement as of the day and year first above written.

<p>WITNESSES:</p> <p>_____ Signature</p> <p>_____ Print Name</p> <p>_____ Signature</p> <p>_____ Print Name</p>	<p>SCHOOL BOARD OF GADSDEN COUNTY, FLORIDA</p> <p>_____ By: REGINALD C. JAMES As its: Superintendent</p> <p>_____ By: ISAAC SIMMONS, JR. As its: Chairman</p>
<p>_____ Signature</p> <p>_____ Print Name</p> <p>_____ Signature</p> <p>_____ Print Name</p>	<p>SEARCHING FOR THE ONE MINISTRIES</p> <p>_____ By:</p> <p>_____ Print Name:</p> <p>_____ As its:</p>

STATE OF FLORIDA
COUNTY OF GADSDEN

The foregoing Lease Agreement was acknowledged before me this _____ day of _____, 2009, by REGINALD C. JAMES as the Superintendent of the School Board of Gadsden County, Florida, and ISAAC SIMMONS, JR., as the Chairman of the School Board of Gadsden County, Florida, on behalf of the Board, who () are personally known to me or () have produced his Florida driver's licenses as identification.

Notary Public
My commission expires: _____

STATE OF FLORIDA
COUNTY OF GADSDEN

The foregoing Lease Agreement was acknowledged before me this _____ day of _____, 2009, by _____ as the _____ of Searching for the One Ministries, on behalf of said Church, who (_____) is personally known to me or (_____) has produced his/her Florida driver's license as identification.

Notary Public
My commission expires: _____

Attachment "A"



Gadsden County Property Appraiser's Office
Clay VanLandingham, CFA
COUNTY APPRAISER

16 S. CALHOUN ST
QUINCY, FL 32353-0585
PH (850) 627-7168
FAX (850) 627-0396

COMPLETE LEGAL DESCRIPTION FOR PARCEL 2-26-3N-2W-0210-0000E-0010

OR 20, P. 398-OR 40, P. 81- LOTS 1 THRU 9 & 13 THRU 25, BLK. E. LOTS 1 THRU 30, BLK. F, LOTS 1 THRU 12, BLK. G, LOTS 1 THRU 24, BLK. H, E. 5 FT. OF LOT 40, BLK. I LOTS 41 THRU 79, BLK. I, HAMPTON HTS. ALSO: CARVER AVE. FROM WESTER ST. E. TO JACKSON ST., AND JACKSON ST. N. FROM ANDERSON AVE. TO CARVER AVE.

Close Window

© 2004 by the County of Gadsden, FL | Website design by gpublic.net